

Nikon

DIGITAL CAMERA

D3400

Reference Manual



- Read this manual thoroughly before using the camera.
- To ensure proper use of the camera, be sure to read “For Your Safety” (page xi).
- After reading this manual, keep it in a readily accessible place for future reference.

En



SnapBridge

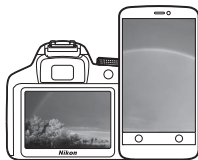

Your images. The world. Connected

Welcome to SnapBridge — Nikon's new family of services to enrich your image experience. SnapBridge eliminates the barrier between your camera and compatible smart device, through a combination of *Bluetooth*® low energy (BLE) technology and a dedicated app. The stories you capture with your Nikon camera and lenses are automatically transferred to the device as they are taken. They can even be uploaded effortlessly to cloud storage services, inviting access across all your devices. You can share your excitement, when and where you want.

Download the SnapBridge app to get started!

Take advantage of the wide-ranging convenience by downloading the SnapBridge app onto your smart device now. Through a few simple steps, this app connects your Nikon cameras with a compatible iPhone®, iPad® and/or iPod touch® or smart devices running on the Android™ operating system. SnapBridge is available free of charge from the Apple App Store®, on Google Play™, and from the following website:

<http://snapbridge.nikon.com>

For the latest information on SnapBridge, visit the Nikon website for your area (☎ xix).



Download on the
App Store



GET IT ON
Google Play

The exciting image experience that SnapBridge offers...



Automatic picture transfer from camera to smart device thanks to the constant connection between the two devices — making online photo sharing easier than ever

NIKON IMAGE SPACE



Upload of photos and thumbnail images to the NIKON IMAGE SPACE cloud service

A range of services that enriches your imaging life, including:

- Imprinting up to two pieces of credit information (e.g. copyright, comments, text and logos) on pictures
- Automatic update of camera's date and time info and location info
- Receive camera's firmware updates



To get the most from your camera, please be sure to read all instructions thoroughly and keep them where they will be read by all who use the product.

Symbols and Conventions

To make it easier to find the information you need, the following symbols and conventions are used:



This icon marks cautions; information that should be read before use to prevent damage to the camera.



This icon marks notes; information that should be read before using the camera.



This icon marks references to other pages in this manual.

Menu items, options, and messages displayed in the camera monitor are shown in **bold**.

Camera Settings

The explanations in this manual assume that default settings are used.

Nikon Manual Viewer 2







Install the Nikon Manual Viewer 2 app on your smartphone or tablet to view Nikon digital camera manuals, anytime, anywhere. Nikon Manual Viewer 2 can be downloaded free of charge from the App Store and on Google Play. Download of the app and any product manuals requires an Internet connection, for which fees may be levied by your phone or Internet service provider.

For Your Safety

Before using the camera for the first time, read the safety instructions in "For Your Safety" (📖 xi–xiv).







Table of Contents

For Your Safety	xi
Notices.....	xv
Bluetooth	xx
Introduction	1
<hr/>	
Getting to Know the Camera	1
The Camera Body.....	1
The Viewfinder.....	4
The Mode Dial.....	5
The  (Info) Button	6
The  Button.....	11
First Steps	12
<hr/>	
Attach the Camera Strap.....	12
Charge the Battery	12
Insert the Battery and a Memory Card	13
Attach a Lens	15
Camera Setup.....	18
Focus the Viewfinder.....	26
Tutorial	27
<hr/>	
Camera Menus: An Overview	27
Using Camera Menus	28
The Battery Level and Number of Exposures Remaining...	31
Basic Photography and Playback	32
<hr/>	
“Point-and-Shoot” Modes ( and )	32
Basic Playback	40
Deleting Unwanted Photographs	41









Guide Mode **42**

The Guide	42
Guide Mode Menus	43
Using the Guide	46

**Matching Settings to the Subject or Situation
(Scene Mode)** **48**

 Portrait	48
 Landscape	49
 Child	49
 Sports	49
 Close up	50
 Night Portrait	50

Special Effects **51**

 Night Vision	52
 VI Super Vivid	52
POP Pop	52
 Photo Illustration	53
 Toy Camera Effect	53
 Miniature Effect	53
 Selective Color	54
 Silhouette	54
 High Key	54
 Low Key	55
Options Available in Live View	56

More on Photography **62**



Choosing a Release Mode	62
Continuous Shooting (Burst Mode)	63
Quiet Shutter Release	65
Self-Timer Mode	66

Focus	69
Focus Mode	69
AF-Area Mode	74
Focus Lock.....	79
Manual Focus	81
Image Quality and Size	84
Image Quality.....	84
Image Size	86
Using the Built-in Flash	87
Auto Pop-up Modes.....	87
Manual Pop-up Modes	89
ISO Sensitivity	93
Remote Control Photography	95
Using an Optional ML-L3 Remote Control	95
P, S, A, and M Modes	98
<hr/>	
Shutter Speed and Aperture	98
Mode P (Programmed Auto)	99
Mode S (Shutter-Priority Auto)	101
Mode A (Aperture-Priority Auto)	103
Mode M (Manual)	105
Long Time-Exposures (M Mode Only).....	107
Exposure	111
Metering.....	111
Autoexposure Lock.....	113
Exposure Compensation.....	115
Flash Compensation.....	117
Preserving Detail in Highlights and Shadows	119
Active D-Lighting.....	119

White Balance	121
Fine-Tuning White Balance	124
Preset Manual.....	126
Picture Controls	132
Selecting a Picture Control	132
Modifying Picture Controls.....	134
Recording and Viewing Movies	138
<hr/>	
Recording Movies	138
Movie Settings.....	141
Viewing Movies	144
Editing Movies	146
Trimming Movies	146
Saving Selected Frames	150
Playback and Deletion	152
<hr/>	
Full-Frame Playback	152
Thumbnail Playback.....	153
Calendar Playback.....	154
The i Button	155
Photo Information	156
Taking a Closer Look: Playback Zoom	165
Protecting Photographs from Deletion	168
Rating Pictures	169
Rating Individual Pictures	169
Rating Multiple Pictures.....	170
Deleting Photographs	171
During Playback.....	171
The Playback Menu	172
Slide Shows	174
Slide Show Options	176

Connections	177
Installing ViewNX-i.....	177
Copying Pictures to the Computer	178
Printing Photographs.....	181
Connecting the Printer	181
Printing Pictures One at a Time	182
Printing Multiple Pictures	183
Viewing Pictures on TV	184
Camera Menus	186
▶ The Playback Menu: <i>Managing Images</i>	186
Playback Menu Options	186
Playback Folder.....	187
Playback Display Options.....	187
Image Review	188
Auto Image Rotation.....	188
Rotate Tall	189
Select to Send to Smart Device	189
📷 The Shooting Menu: <i>Shooting Options</i>	190
Shooting Menu Options.....	190
Reset Shooting Menu	192
ISO Sensitivity Settings.....	192
Color Space.....	194
Noise Reduction.....	195
Vignette Control	195
Auto Distortion Control	196
Built-in AF-assist Illuminator	196
Flash Cntrl for Built-in Flash/Optional Flash	197
Optical VR.....	198

Y The Setup Menu: <i>Camera Setup</i>	199
Setup Menu Options	199
Reset Setup Options	201
Format Memory Card	201
Date Stamp	202
Time Zone and Date	205
Language	205
Monitor Brightness.....	205
Info Display Format.....	206
Auto Info Display	206
Auto off Timers	207
Self-Timer.....	208
Remote on Duration (ML-L3).....	208
Image Dust Off Ref Photo	209
Image Comment	211
Copyright Information.....	212
Beep.....	213
Flicker Reduction	213
Buttons	214
Rangefinder	216
Manual Focus Ring in AF Mode	217
File Number Sequence	218
Storage Folder	219
File Naming.....	221
Location Data	221
Airplane Mode	222
Connect to Smart Device	222
Send to Smart Device (Auto)	223
Bluetooth	223
Eye-Fi Upload	224
Conformity Marking.....	225
Slot Empty Release Lock.....	226
Reset All Settings	226
Firmware Version	226

 The Retouch Menu: <i>Creating Retouched Copies</i>.....	227
Retouch Menu Options	227
Creating Retouched Copies	228
NEF (RAW) Processing	230
Trim	232
Resize	233
D-Lighting.....	235
Quick Retouch	236
Red-Eye Correction	236
Straighten	237
Distortion Control	237
Perspective Control	238
Fisheye	238
Filter Effects	239
Monochrome	240
Image Overlay	241
Color Outline.....	243
Photo Illustration.....	244
Color Sketch	244
Miniature Effect.....	245
Selective Color.....	246
Painting.....	248
Side-by-side Comparison	249
 Recent Settings	251
Technical Notes	252
<hr/>	
Compatible Lenses.....	252
Compatible CPU Lenses	252
Compatible Non-CPU Lenses	254
The Nikon Creative Lighting System (CLS).....	262
Other Accessories.....	267
Attaching a Power Connector and AC Adapter.....	270

Caring for the Camera	272
Storage.....	272
Cleaning.....	272
Image Sensor Cleaning	273
Caring for the Camera and Battery: Cautions	276
Available Settings.....	281
Troubleshooting	282
Battery/Display.....	282
Shooting (All Modes)	283
Shooting (P, S, A, M).....	287
Playback.....	288
Bluetooth	289
Miscellaneous.....	289
Error Messages.....	290
Specifications	295
AF-P DX NIKKOR 18–55mm f/3.5–5.6G VR and	
AF-P DX NIKKOR 18–55mm f/3.5–5.6G Lenses	306
AF-P DX NIKKOR 70–300mm f/4.5–6.3G ED VR and	
AF-P DX NIKKOR 70–300mm f/4.5–6.3G ED Lenses.....	312
AF-S DX NIKKOR 55–200mm f/4–5.6G ED VR II Lenses.....	317
Memory Card Capacity	323
Battery Life.....	324
Index	326

For Your Safety

To prevent damage to property or injury to yourself or to others, read “For Your Safety” in its entirety before using this product.

Keep these safety instructions where all those who use this product will read them.

⚠ DANGER: Failure to observe the precautions marked with this icon carries a high risk of death or severe injury.

⚠ WARNING: Failure to observe the precautions marked with this icon could result in death or severe injury.

⚠ CAUTION: Failure to observe the precautions marked with this icon could result in injury or property damage.



WARNING

- **Do not use while walking or operating a motor vehicle.**

Failure to observe this precaution could result in accidents or other injury.

- **Do not disassemble or modify this product. Do not touch internal parts that become exposed as the result of a fall or other accident.**

Failure to observe these precautions could result in electric shock or other injury.

- **Should you notice any abnormalities such as the product producing smoke, heat, or unusual odors, immediately disconnect the battery or power source.**

Continued operation could result in fire, burns or other injury.

- **Keep dry. Do not handle with wet hands. Do not handle the plug with wet hands.**

Failure to observe these precautions could result in fire or electric shock.

- **Do not let your skin remain in prolonged contact with this product while it is on or plugged in.**

Failure to observe this precaution could result in low-temperature burns.

- **Do not use this product in the presence of flammable dust or gas such as propane, gasoline or aerosols.**

Failure to observe this precaution could result in explosion or fire.

- **Do not directly view the sun or other bright light source through the lens or camera.**

Failure to observe this precaution could result in visual impairment.

- **Do not aim the flash or AF-assist illuminator at the operator of a motor vehicle.**

Failure to observe this precaution could result in accidents.

- **Keep this product out of reach of children.**

Failure to observe this precaution could result in injury or product malfunction. In addition, note that small parts constitute a choking hazard. Should a child swallow any part of this product, seek immediate medical attention.

- **Do not entangle, wrap or twist the straps around your neck.**

Failure to observe this precaution could result in accidents.

- **Do not use batteries, chargers, or AC adapters not specifically designated for use with this product. When using batteries, chargers, and AC adapters designated for use with this product, do not:**

- **Damage, modify, forcibly tug or bend the cords or cables, place them under heavy objects, or expose them to heat or flame.**
- **Use travel converters or adapters designed to convert from one voltage to another or with DC-to-AC inverters.**

Failure to observe these precautions could result in fire or electric shock.

- **Do not handle the plug when charging the product or using the AC adapter during thunderstorms.**

Failure to observe this precaution could result in electric shock.

- **Do not handle with bare hands in locations exposed to extremely high or low temperatures.**

Failure to observe this precaution could result in burns, or frostbite.



CAUTION

- **Do not leave the lens pointed at the sun or other strong light sources.**

Light focused by the lens could cause fire or damage to product's internal parts. When shooting backlit subjects, keep the sun well out of the frame. Sunlight focused into the camera when the sun is close to the frame could cause fire.

- **Turn this product off when its use is prohibited. Disable wireless features when the use of wireless equipment is prohibited.**

The radio-frequency emissions produced by this product could interfere with equipment onboard aircraft or in hospitals or other medical facilities.

- **Remove the battery and disconnect the AC adapter if this product will not be used for an extended period.**

Failure to observe this precaution could result in fire or product malfunction.

- **Do not touch moving parts of the lens or other moving parts.**

Failure to observe this precaution could result in injury.

- **Do not fire the flash in contact with or in close proximity to the skin or objects.**

Failure to observe this precaution could result in burns or fire.

- **Do not leave the product where it will be exposed to extremely high temperatures, for an extended period such as in an enclosed automobile or in direct sunlight.**

Failure to observe this precaution could result in fire or product malfunction.



DANGER (Batteries)

- **Do not mishandle batteries.**

Failure to observe the following precautions could result in the batteries leaking, overheating, rupturing, or catching fire:

- Use only rechargeable batteries approved for use in this product.
 - Do not expose batteries to flame or excessive heat.
 - Do not disassemble.
 - Do not short-circuit the terminals by touching them to necklaces, hairpins, or other metal objects.
 - Do not expose batteries or the products in which they are inserted to powerful physical shocks.
-

- **Do not attempt to recharge EN-EL14a rechargeable batteries using chargers not specifically designated for this purpose.**

Failure to observe this precaution could result in the batteries leaking, overheating, rupturing, or catching fire.

- **If battery liquid comes into contact with the eyes, rinse with plenty of clean water and seek immediate medical attention.**

Delaying action could result in eye injuries.



WARNING (Batteries)

- **Keep batteries out of reach of children.**

Should a child swallow a battery, seek immediate medical attention.

- **Do not immerse batteries in water or expose to rain.**

Failure to observe this precaution could result in fire or product malfunction. Immediately dry the product with a towel or similar object should it become wet.

- **Discontinue use immediately should you notice any changes in the batteries, such as discoloration or deformation. Cease charging EN-EL14a rechargeable batteries if they do not charge in the specified period of time.**

Failure to observe these precautions could result in the batteries leaking, overheating, rupturing, or catching fire.

- **Prior to disposal, insulate battery terminals with tape.**

Overheating, rupture, or fire may result should metal objects come into contact with the terminals. Recycle or dispose of batteries in accord with local regulations.

- **If battery liquid comes into contact with a person's skin or clothing, immediately rinse the affected area with plenty of clean water.**

Failure to observe this precaution could result in skin irritation.

Notices

- No part of the manuals included with this product may be reproduced, transmitted, transcribed, stored in a retrieval system, or translated into any language in any form, by any means, without Nikon's prior written permission.
- Nikon reserves the right to change the appearance and specifications of the hardware and software described in these manuals at any time and without prior notice.
- Nikon will not be held liable for any damages resulting from the use of this product.
- While every effort has been made to ensure that the information in these manuals is accurate and complete, we would appreciate it were you to bring any errors or omissions to the attention of the Nikon representative in your area (address provided separately).

Notice for Customers in Canada

CAN ICES-3 B / NMB-3 B

Notices for Customers in Europe

CAUTION: RISK OF EXPLOSION IF BATTERY IS REPLACED BY AN INCORRECT TYPE. DISPOSE OF USED BATTERIES ACCORDING TO THE INSTRUCTIONS.

This symbol indicates that electrical and electronic equipment is to be collected separately.



This symbol on the battery indicates that the battery is to be collected separately.



The following apply only to users in European countries:

- This product is designated for separate collection at an appropriate collection point. Do not dispose of as household waste.
- Separate collection and recycling helps conserve natural resources and prevent negative consequences for human health and the environment that might result from incorrect disposal.
- For more information, contact the retailer or the local authorities in charge of waste management.

The following apply only to users in European countries:

- All batteries, whether marked with this symbol or not, are designated for separate collection at an appropriate collection point. Do not dispose of as household waste.
- For more information, contact the retailer or the local authorities in charge of waste management.

Notices for Customers in the U.S.A.

The Battery Charger

IMPORTANT SAFETY INSTRUCTIONS—SAVE THESE INSTRUCTIONS

DANGER—TO REDUCE THE RISK OF FIRE OR ELECTRIC SHOCK, CAREFULLY FOLLOW THESE INSTRUCTIONS

For connection to a supply not in the U.S.A., use an attachment plug adapter of the proper configuration for the power outlet if needed. This power unit is intended to be correctly oriented in a vertical or floor mount position.

Federal Communications Commission (FCC) Radio Frequency Interference Statement

This equipment has been tested and found to comply with the limits for a Class B digital device, pursuant to Part 15 of the FCC rules. These limits are designed to provide reasonable protection against harmful interference in a residential installation. This equipment generates, uses, and can radiate radio frequency energy and, if not installed and used in accordance with the instructions, may cause harmful interference to radio communications. However, there is no guarantee that interference will not occur in a particular installation. If this equipment does cause harmful interference to radio or television reception, which can be determined by turning the equipment off and on, the user is encouraged to try to correct the interference by one or more of the following measures:

- Reorient or relocate the receiving antenna.
- Increase the separation between the equipment and receiver.
- Connect the equipment into an outlet on a circuit different from that to which the receiver is connected.
- Consult the dealer or an experienced radio/television technician for help.



Nikon
D3400

CAUTIONS

Modifications

The FCC requires the user be notified that any changes or modifications made to this device that are not expressly approved by Nikon Corporation may void the user's authority to operate the equipment.

Interface Cables

Use the interface cables sold or provided by Nikon for your equipment. Using other interface cables may exceed the limits of Class B Part 15 of the FCC rules.

Notice for Customers in the State of California

WARNING: Handling the cord on this product may expose you to lead, a chemical known to the State of California to cause birth defects or other reproductive harm. *Wash hands after handling.*

Nikon Inc., 1300 Walt Whitman Road, Melville, New York 11747-3064, U.S.A.
Tel.: 631-547-4200

Notice Concerning Prohibition of Copying or Reproduction

Note that simply being in possession of material that has been digitally copied or reproduced by means of a scanner, digital camera, or other device may be punishable by law.

- **Items prohibited by law from being copied or reproduced**

Do not copy or reproduce paper money, coins, securities, government bonds, or local government bonds, even if such copies or reproductions are stamped "Sample."

The copying or reproduction of paper money, coins, or securities which are circulated in a foreign country is prohibited.

Unless the prior permission of the government has been obtained, the copying or reproduction of unused postage stamps or post cards issued by the government is prohibited.

The copying or reproduction of stamps issued by the government and of certified documents stipulated by law is prohibited.

- **Cautions on certain copies and reproductions**

The government has issued cautions on copies or reproductions of securities issued by private companies (shares, bills, checks, gift certificates, etc.), commuter passes, or coupon tickets, except when a minimum of necessary copies are to be provided for business use by a company. Also, do not copy or reproduce passports issued by the government, licenses issued by public agencies and private groups, ID cards, and tickets, such as passes and meal coupons.

- **Comply with copyright notices**

Under copyright law, photographs or recordings of copyrighted works made with the camera can not be used without the permission of the copyright holder. Exceptions apply to personal use, but note that even personal use may be restricted in the case of photographs or recordings of exhibits or live performances.

Disposing of Data Storage Devices

Please note that deleting images or formatting memory cards or other data storage devices does not completely erase the original image data. Deleted files can sometimes be recovered from discarded storage devices using commercially available software, potentially resulting in the malicious use of personal image data. Ensuring the privacy of such data is the user's responsibility.

Before discarding a data storage device or transferring ownership to another person, erase all data using commercial deletion software, or format the device and then completely refill it with images containing no private information (for example, pictures of empty sky). Care should be taken to avoid injury when physically destroying data storage devices.

Before discarding the camera or transferring ownership to another person, you should also use the **Reset all settings** option in the camera setup menu to delete any personal network information.

AVC Patent Portfolio License

THIS PRODUCT IS LICENSED UNDER THE AVC PATENT PORTFOLIO LICENSE FOR THE PERSONAL AND NON-COMMERCIAL USE OF A CONSUMER TO (i) ENCODE VIDEO IN COMPLIANCE WITH THE AVC STANDARD ("AVC VIDEO") AND/OR (ii) DECODE AVC VIDEO THAT WAS ENCODED BY A CONSUMER ENGAGED IN A PERSONAL AND NON-COMMERCIAL ACTIVITY AND/OR WAS OBTAINED FROM A VIDEO PROVIDER LICENSED TO PROVIDE AVC VIDEO. NO LICENSE IS GRANTED OR SHALL BE IMPLIED FOR ANY OTHER USE. ADDITIONAL INFORMATION MAY BE OBTAINED FROM MPEG LA, L.L.C. SEE <http://www.mpegla.com>

Use Only Nikon Brand Electronic Accessories

Nikon cameras are designed to the highest standards and include complex electronic circuitry. Only Nikon brand electronic accessories (including chargers, batteries, AC adapters, and flash accessories) certified by Nikon specifically for use with this Nikon digital camera are engineered and proven to operate within the operational and safety requirements of this electronic circuitry.

The use of non-Nikon electronic accessories could damage the camera and may void your Nikon warranty. The use of third-party rechargeable Li-ion batteries not bearing the Nikon holographic seal shown at right could interfere with normal operation of the camera or result in the batteries overheating, igniting, rupturing, or leaking.

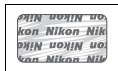

For more information about Nikon brand accessories, contact a local authorized Nikon dealer.

✔ Use Only Nikon Brand Accessories

Only Nikon brand accessories certified by Nikon specifically for use with your Nikon digital camera are engineered and proven to operate within its operational and safety requirements. THE USE OF NON-NIKON ACCESSORIES COULD DAMAGE YOUR CAMERA AND MAY VOID YOUR NIKON WARRANTY.

✔ Before Taking Important Pictures

Before taking pictures on important occasions (such as at weddings or before taking the camera on a trip), take a test shot to ensure that the camera is functioning normally. Nikon will not be held liable for damages or lost profits that may result from product malfunction.

✔ Life-Long Learning

As part of Nikon's "Life-Long Learning" commitment to ongoing product support and education, continually-updated information is available online at the following sites:

- **For users in the U.S.A.:** <http://www.nikonusa.com/>
- **For users in Europe and Africa:** <http://www.europe-nikon.com/support/>
- **For users in Asia, Oceania, and the Middle East:** <http://www.nikon-asia.com/>

Visit these sites to keep up-to-date with the latest product information, tips, answers to frequently-asked questions (FAQs), and general advice on digital imaging and photography. Additional information may be available from the Nikon representative in your area. See the following URL for contact information: <http://imaging.nikon.com/>

Bluetooth

This product is controlled by the United States Export Administration Regulations (EAR). The permission of the United States government is not required for export to countries other than the following, which as of this writing are subject to embargo or special controls: Cuba, Iran, North Korea, Sudan, and Syria (list subject to change).

The use of wireless devices may be prohibited in some countries or regions. Contact a Nikon-authorized service representative before using the wireless features of this product outside the country of purchase.

Notice for Customers in the U.S.A. and Canada

This device complies with Part 15 of FCC Rules and Industry Canada licence-exempt RSS standard(s). Operation is subject to the following two conditions: (1) this device may not cause interference, and (2) this device must accept any interference, including interference that may cause undesired operation of the device.

FCC WARNING

The FCC requires the user to be notified that any changes or modifications made to this device that are not expressly approved by Nikon Corporation may void the user's authority to operate the equipment.

FCC Radio Frequency Interference Statement

Note: This equipment has been tested and found to comply with the limits for a Class B digital device, pursuant to part 15 of the FCC Rules. These limits are designed to provide reasonable protection against harmful interference in a residential installation. This equipment generates, uses and can radiate radio frequency energy and, if not installed and used in accordance with the instructions, may cause harmful interference to radio communications. However, there is no guarantee that interference will not occur in a particular installation. If this equipment does cause harmful interference to radio or television reception, which can be determined by turning the equipment off and on, the user is encouraged to try to correct the interference by one or more of the following measures:

- Reorient or relocate the receiving antenna.
- Increase the separation between the equipment and receiver.
- Connect the equipment into an outlet on a circuit different from that to which the receiver is connected.
- Consult the dealer or an experienced radio/TV technician for help.

Co-location

This transmitter must not be co-located or operated in conjunction with any other antenna or transmitter.

Nikon Inc., 1300 Walt Whitman Road, Melville, New York 11747-3064, U.S.A.
Tel.: 631-547-4200

FCC/IC RF Exposure Statement

The available scientific evidence does not show that any health problems are associated with using low power wireless devices. There is no proof, however, that these low power wireless devices are absolutely safe. Low power wireless devices emit low levels of radio frequency energy (RF) in the microwave range while being used. Whereas high levels of RF can produce health effects (by heating tissue), exposure of low-level RF that does not produce heating effects causes no known adverse health effects. Many studies of low-level RF exposures have not found any biological effects. Some studies have suggested that some biological effects might occur, but such findings have not been confirmed by additional research. The D3400, which is equipped with a TYPE1FJ (FCC ID:VPYLB1FJ / IC ID:772C-LB1FJ), has been tested and found to comply with FCC/IC radiation exposure limits set forth for an uncontrolled environment and meets the FCC radio frequency (RF) Exposure Guidelines in Supplement C to OET65 and RSS-102 of the IC radio frequency (RF) Exposure rules. Please refer to the SAR test report that was uploaded to FCC website.

Notices for Customers in Europe

Hereby, Nikon Corporation declares that the radio equipment type D3400 is in compliance with Directive 2014/53/EU. The full text of the EU declaration of conformity is available at the following internet address:

http://imaging.nikon.com/support/pdf/DoC_D3400.pdf.



Notice for Customers in Singapore

Trade Name: **Nikon**
Model: D3400

This device complies with radio-frequency regulations. The content of certification labels not affixed to the device is given below.

Complies with
IDA Standards
DA103423

Security

Although one of the benefits of this product is that it allows others to freely connect for the wireless exchange of data anywhere within its range, the following may occur if security is not enabled:

- **Data theft:** Malicious third-parties may intercept wireless transmissions to steal user IDs, passwords, and other personal information.
- **Unauthorized access:** Unauthorized users may gain access to the network and alter data or perform other malicious actions. Note that due to the design of wireless networks, specialized attacks may allow unauthorized access even when security is enabled.
- **Unsecured networks:** Connecting to open networks may result in unauthorized access. Use secure networks only.

Introduction

Getting to Know the Camera

Take a few moments to familiarize yourself with camera controls and displays. You may find it helpful to bookmark this section and refer to it as you read through the rest of the manual.

The Camera Body

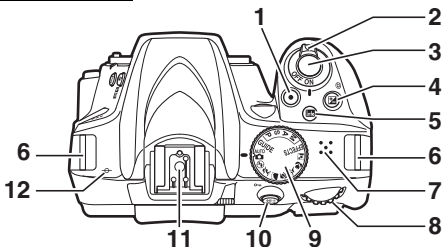

1	Movie-record button	139	8	Command dial	
2	Power switch.....	19	9	Mode dial.....	5
3	Shutter-release button	35, 36	10	AE-L/AF-L button	80, 113, 168, 215
4	AF-ON button.....	106, 116, 117	11	Accessory shoe (for optional flash units)	262, 268
5	Info (information) button.....	6, 8, 143	12	Focal plane mark (⊖)	82
6	Eyelets for camera strap.....	12			
7	Speaker				

✓ The Speaker

Do not place the speaker in close proximity to magnetic devices. Failure to observe this precaution could affect the data recorded on the magnetic devices.

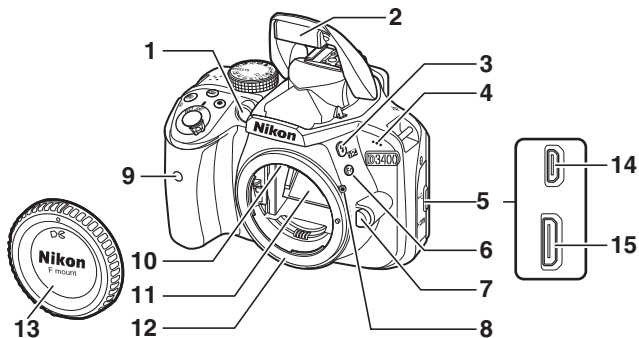

<p>1 AF-assist illuminator73, 196 Self-timer lamp67 Red-eye reduction lamp88, 90</p>	<p>9 Infrared receiver for ML-L3 remote control.....96</p>
<p>2 Built-in flash.....87</p>	<p>10 CPU contacts</p>
<p>3 / button.....87, 89, 117</p>	<p>11 Mirror..... 274</p>
<p>4 Microphone 139, 141</p>	<p>12 Lens mount..... 15, 82</p>
<p>5 Connector cover</p>	<p>13 Body cap..... 15, 268</p>
<p>6 Fn button 214</p>	<p>14 USB connector 178, 181</p>
<p>7 Lens release button.....16</p>	<p>15 HDMI connector 184</p>
<p>8 Mounting mark15</p>	

✓ Close the Connector Cover

Close the connector cover when the connectors are not in use. Foreign matter in the connectors can interfere with data transfer.

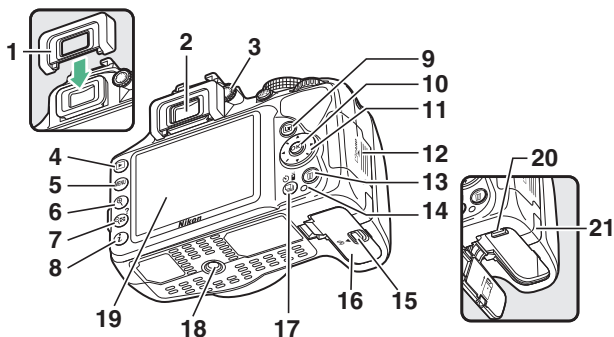

1 Rubber eyecup	68	13 button	41, 171
2 Viewfinder eyepiece.....	4, 26, 68	14 Memory card access lamp	
3 Diopter adjustment control	26	14, 36
4 button.....	40, 152	15 Battery-chamber cover latch	
5 MENU button.....	27, 186	13, 14
6 button	165	16 Battery-chamber cover	13, 14
7 button	28, 153, 165	17 button....	62, 63, 65, 66, 95
8 button.....	11, 155	18 Tripod socket	
9 button.....	32, 138	19 Monitor	6, 32, 40, 138, 152
10 (OK) button.....	28	20 Battery latch.....	13, 14
11 Multi selector	28	21 Power connector cover for	
12 Memory card slot cover.....	13, 14	optional power connector	270

The Viewfinder

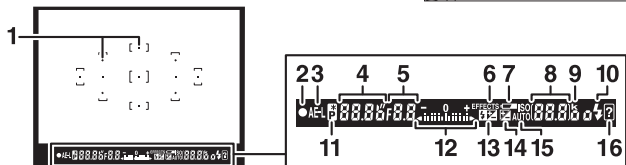
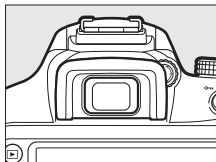

1	Focus points.....26, 34, 74, 76	9	"k" (appears when memory remains for over 1000 exposures)31
2	Focus indicator35, 82	10	Flash-ready indicator38
3	Autoexposure (AE) lock indicator 113	11	Flexible program indicator..... 100
4	Shutter speed98, 101, 105	12	Exposure indicator 106
5	Aperture (f-number) ...98, 103, 105		Exposure compensation display 115
6	Special effects mode indicator...51		Electronic rangefinder..... 216
7	Low battery warning31	13	Flash compensation indicator 117
8	Number of exposures remaining31	14	Exposure compensation indicator 115
	Number of shots remaining before memory buffer fills64	15	Auto ISO sensitivity indicator 193
	White balance recording indicator 126, 127	16	Warning indicator..... 290
	Exposure compensation value 115		
	Flash compensation value..... 117		
	ISO sensitivity93, 192		

Note: Display shown with all indicators lit for illustrative purposes.

The Mode Dial

The camera offers a choice of the following shooting modes and **GUIDE** mode:

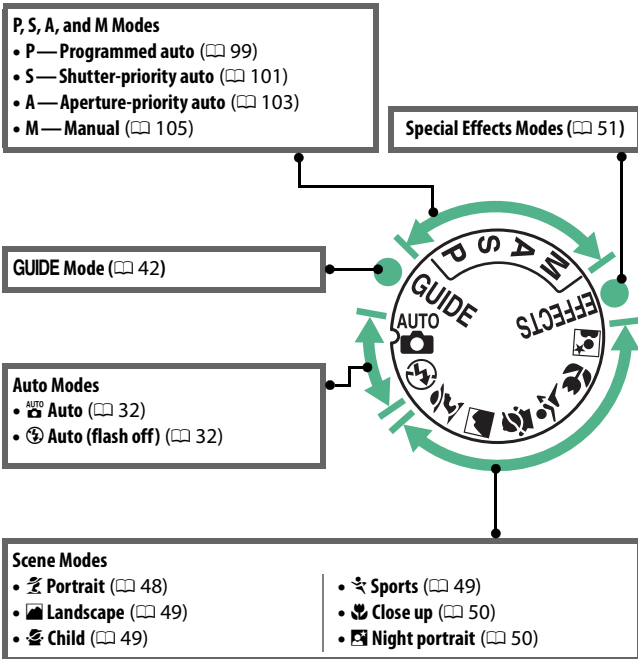

The **info** (Info) Button

Press the **info** button to view the information display or cycle through display options.

■ **Viewfinder Photography**

To view shutter speed, aperture, the number of exposures remaining, AF-area mode, and other shooting information in the monitor, press the **info** button.

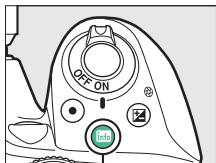

info button



- | | |
|---|---|
| 1 Shooting mode
AUTO
auto/
Ⓜ auto (flash off).....32
Scene modes48
Special effects mode51
P, S, A, and M modes98 | 4 Vignette control indicator 195 |
| 2 Eye-Fi connection indicator 224 | 5 Date stamp indicator 202 |
| 3 Bluetooth connection
indicator20, 223
Airplane mode 222 | 6 Vibration reduction indicator 17 |
| | 7 Flash control indicator 197
Flash compensation indicator for
optional flash units 265 |
| | 8 Release mode62 |
| | 9 “Beep” indicator 213 |

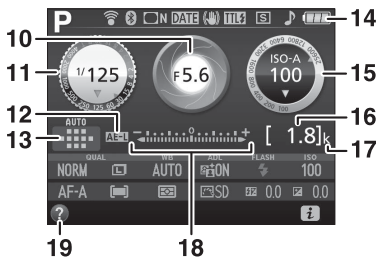

<p>10 Aperture (f-number) 98, 103, 105 Aperture display 104, 106</p> <p>11 Shutter speed 98, 101, 105 Shutter-speed display..... 102, 106</p> <p>12 Autoexposure (AE) lock indicator 113</p> <p>13 AF-area mode indicator 74 Focus point..... 76</p> <p>14 Battery indicator 31</p> <p>15 ISO sensitivity 93 ISO sensitivity display 93, 194 Auto ISO sensitivity indicator 193</p>	<p>16 Number of exposures remaining 31 White balance recording indicator 126</p> <p>17 "k" (appears when memory remains for over 1000 exposures) 31</p> <p>18 Exposure indicator 106 Exposure compensation indicator 115</p> <p>19 Help icon..... 290</p>
---	---

Note: Display shown with all indicators lit for illustrative purposes.

Turning the Monitor Off

To clear shooting information from the monitor, press the **Info** button or press the shutter-release button halfway. The monitor will turn off automatically if no operations are performed for about 8 seconds (for information on choosing how long the monitor stays on, see **Auto off timers** on page 207).

■ Live View and Movie Mode

To start live view, press the **Lv** button during viewfinder photography. You can then press the **Info** button to cycle through display options as shown below.

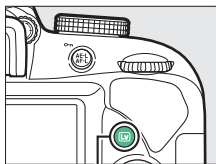

Lv button

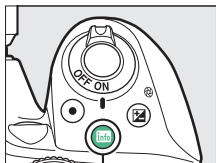

Info button



Show photo indicators



Show movie indicators
(138, 143) *

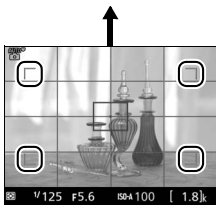

Framing grid*

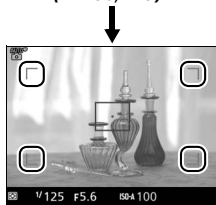

Hide indicators*

* A crop showing the area recorded is displayed during movie recording; circled areas indicate the edges of the movie frame crop (the area outside the movie frame crop is grayed out when movie indicators are displayed).

The Live View Display

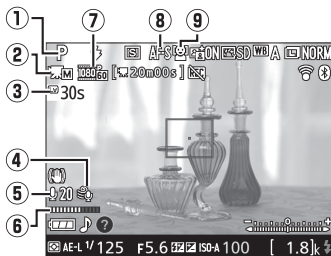

Item	Description	
① Shooting mode	The mode currently selected with the mode dial.	32, 48, 51, 98
② Manual movie settings indicator	Displayed when On is selected for Manual movie settings in mode M .	142
③ Time remaining	The amount of time remaining before live view ends automatically. Displayed if shooting will end in 30 s or less.	10
④ Wind noise reduction	Displayed when On is selected for Movie settings > Wind noise reduction in the shooting menu.	142
⑤ Microphone sensitivity	Microphone sensitivity for movie recording.	141
⑥ Sound level	Sound level for audio recording. Displayed in red if level is too high; adjust microphone sensitivity accordingly.	141
⑦ Movie frame size	The frame size of movies recorded in movie mode.	141
⑧ Focus mode	The current focus mode.	70
⑨ AF-area mode	The current AF-area mode.	75

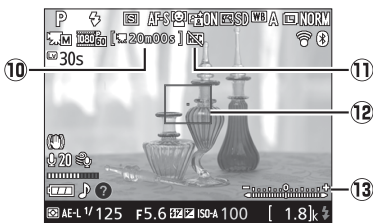

Item	Description	📖
10 Time remaining (movie mode)	The recording time remaining in movie mode.	139
11 "No movie" icon	Indicates that movies can not be recorded.	—
12 Focus point	The current focus point. The display varies with the option selected for AF-area mode (📖 75).	75
13 Exposure indicator	Indicates whether the photograph would be under- or over-exposed at current settings (mode M only).	106

Note: Display shown with all indicators lit for illustrative purposes.

✔ The Count Down Display

A count down will be displayed 30 s before live view ends automatically (📖 9); the timer turns red 5 s before the auto off timer expires (📖 207) or if live view is about to end to protect the internal circuits. Depending on shooting conditions, the timer may appear immediately when live view is selected. Movie recording will end automatically when the timer expires, regardless of the amount of recording time available.

The *i* Button

To change the settings at the bottom of the information display, press the *i* button, then highlight items using the multi selector and press **OK** to view options for the highlighted item. You can also change settings by pressing the *i* button during live view.

- **Image quality** (📖 84)
- **Image size** (📖 86)
- **White balance** (📖 121)
- **Active D-Lighting** (📖 119)
- **Flash mode** (📖 88, 90)
- **ISO sensitivity** (📖 93)
- **Focus mode** (📖 69)
- **AF-area mode** (📖 74)
- **Metering** (📖 111)
- **Set Picture Control** (📖 132)
- **Flash compensation** (📖 117)
- **Exposure compensation** (📖 115)

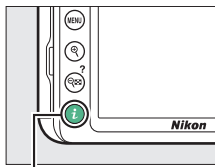

i button



First Steps

Attach the Camera Strap

Attach the strap securely to the two camera eyelets.

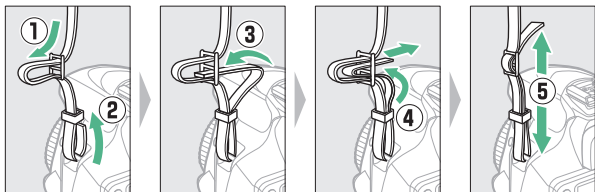

Charge the Battery

If a plug adapter is supplied, raise the wall plug and connect the plug adapter as shown below at left, making sure the plug is fully inserted. Insert the battery and plug the charger in. An exhausted battery will fully charge in about an hour and 50 minutes.

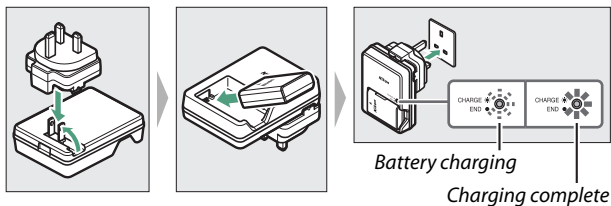

✓ The Battery and Charger

Read and follow the warnings and cautions on pages xi–xiv and 276–280 of this manual.

Insert the Battery and a Memory Card

Before inserting or removing the battery or memory cards, confirm that power switch is in the **OFF** position. Insert the battery as shown, using the battery to keep the orange battery latch pressed to one side. The latch locks the battery in place when the battery is fully inserted.

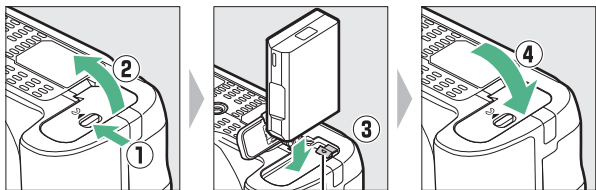

Battery latch

Holding the memory card in the orientation shown, slide it in until it clicks into place.

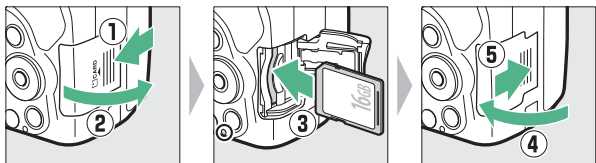

The Clock Battery

The camera clock is powered by an independent, rechargeable power source, which is charged as necessary when the main battery is installed. Three days of charging will power the clock for about a month. If a message warning that the clock is not set is displayed when the camera is turned on, the clock battery is exhausted and the clock has been reset. Set the clock to the correct time and date.

■ Removing the Battery and Memory Cards

Removing the Battery

To remove the battery, turn the camera off and open the battery-chamber cover. Press the battery latch in the direction shown by the arrow to release the battery and then remove the battery by hand.

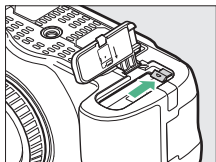

Removing Memory Cards

After confirming that the memory card access lamp is off, turn the camera off, open the memory card slot cover, and press the card in to eject it (①). The card can then be removed by hand (②).

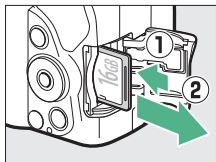

✓ Memory Cards

- Memory cards may be hot after use. Observe due caution when removing memory cards from the camera.
- Do not remove memory cards from the camera, turn the camera off, or remove or disconnect the power source during formatting or while data are being recorded, deleted, or copied to a computer. Failure to observe these precautions could result in loss of data or in damage to the camera or card.
- Do not touch the card terminals with your fingers or metal objects.
- Do not bend, drop, or subject to strong physical shocks.
- Do not apply force to the card casing. Failure to observe this precaution could damage the card.
- Do not expose to water, heat, high levels of humidity, or direct sunlight.
- Do not format memory cards in a computer.

Attach a Lens

Be careful to prevent dust from entering the camera when the lens or body cap is removed. The lens generally used in this manual for illustrative purposes is an AF-P DX NIKKOR 18–55mm f/3.5–5.6G VR.

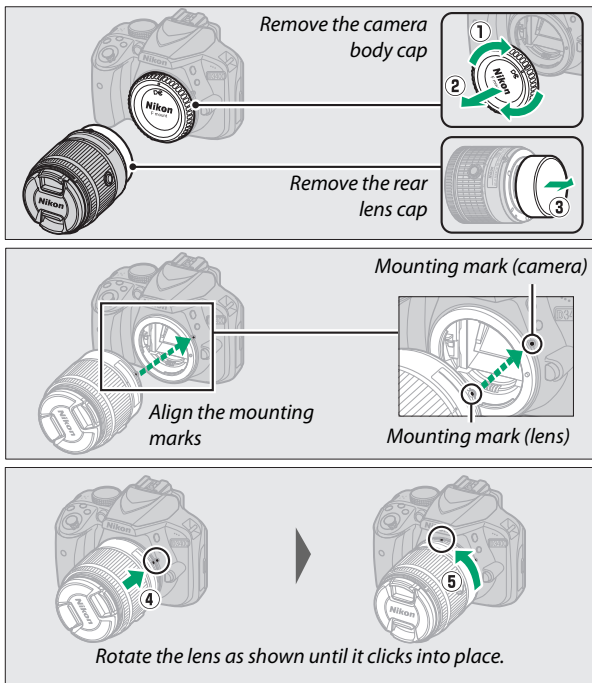

Be sure to remove the lens cap before taking pictures.

Lenses with Retractable Lens Barrel Buttons

Before using the camera, unlock and extend the lens. Keeping the retractable lens barrel button pressed (①), rotate the zoom ring as shown (②).

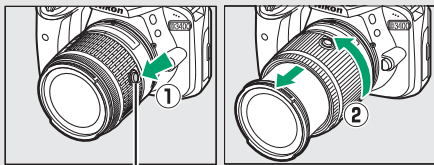

Retractable lens barrel button

Pictures can not be taken when the lens is retracted; if an error message is displayed as a result of the camera having been turned on with the lens retracted, rotate the zoom ring until the message is no longer displayed.



Detaching the Lens

Be sure the camera is off when removing or exchanging lenses. To remove the lens, press and hold the lens release button (①) while turning the lens clockwise (②). After removing the lens, replace the lens caps and camera body cap.

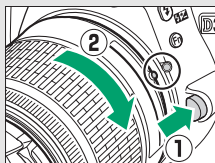

Vibration Reduction (VR)

Vibration reduction can be enabled by selecting **On** for **Optical VR** in the shooting menu (☰ 198), if the lens supports this option, or by sliding the lens vibration reduction switch to **ON**, if the lens is equipped with a vibration reduction switch. A vibration reduction indicator appears in the information display when vibration reduction is on.



Retracting Lenses with Retractable Lens Barrel Buttons

To retract the lens when the camera is not in use, hold the retractable lens barrel button (①) and rotate the zoom ring to the "L" (lock) position as shown (②). Retract the lens before removing it from the camera, and be careful not to press the retractable lens barrel button when attaching or removing the lens.

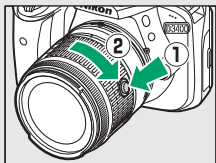

Camera Setup

■ Setup Using a Smartphone or Tablet

Before proceeding, check the camera to ensure that the battery is fully charged and the memory card has space available. On your smartphone or tablet (below “smart device”), install the SnapBridge app as described inside the front cover and enable Bluetooth. Note that the actual connection to the camera will be made using the SnapBridge app; do not use Bluetooth settings in the settings app on your smart device. The instructions that follow refer to version 2.0 of the SnapBridge app; for information on the latest version, see the *SnapBridge Connection Guide* (pdf), available for download from the following website:



<http://downloadcenter.nikonimglib.com>

The actual camera and smart device displays may differ from those shown below.

1 **Camera:** Turn the camera on. A language-selection dialog will be displayed.



Use the multi selector and **OK** button to navigate the menus.

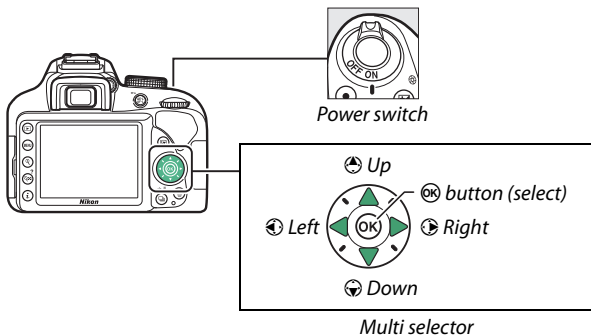

Press **Up** and **Down** to highlight a language and press **OK** to select. The language can be changed at any time using the **Language** option in the setup menu.

- 2 Camera:** When the dialog at right is displayed, press **OK**. If the dialog at right is not displayed or if you wish to configure the camera again, highlight **Connect to smart device** in the setup menu and press **OK**. If you do not wish to use a smart device to configure the camera, set the clock manually (📖 25).

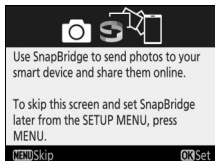

- 3 Camera/smart device: Start pairing.**

The camera will wait for a connection; launch the SnapBridge app on the smart device and follow the on-screen instructions to tap the name of the camera you want to pair with.

- 4 Camera:** Confirm that the camera displays the message shown at right and ready the smart device.

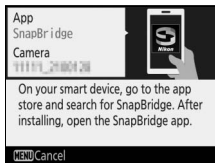

- 5 Smart device:** Launch the SnapBridge app and tap **Pair with camera**. If prompted to choose a camera, tap the camera name.



- 6 Smart device:** Tap the camera name in the “Pair with camera” dialog. Users who are pairing a camera with an iOS device for the first time will first be presented with pairing instructions; after reading the instructions, scroll to the bottom of the display and tap **Understood**. If you are then prompted to choose an accessory, tap the camera name again (there may be some delay before the camera name is displayed).



- 7 Camera/smart device:** Confirm that the camera and smart device display the same six-digit number. Some versions of iOS may not display a number; if no number displayed, proceed to Step 8.

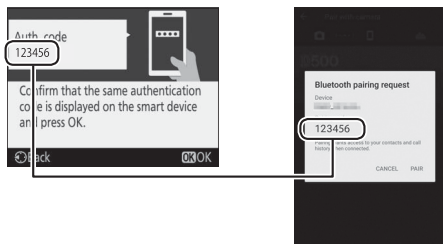

- 8 Camera/smart device:** Press **OK** on the camera and tap **PAIR** on the smart device (the display varies with the device and operating system).

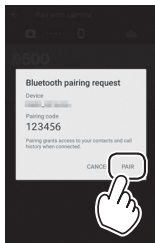
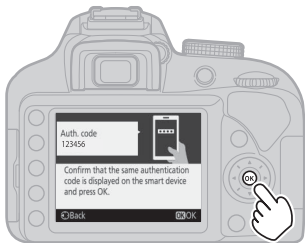

- 9 Camera/smart device: Complete pairing.**



- **Camera:** Press **OK** when the message at right is displayed.

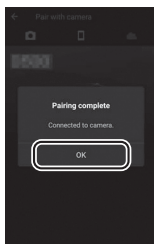

- **Smart device:** Tap **OK** when the message at right is displayed.



10 Camera: Follow the on-screen instructions to complete setup.

- **To allow the camera to add location data to photos**, select **Yes** in response to “Download location data from smart device?” and then enable location services on the smart device and enable **Auto link options** > **Synchronize location data** in the SnapBridge app  tab.
- **To synchronize the camera clock with the time provided by the smart device**, select **Yes** in response to “Sync clock with smart device?” and then enable **Auto link options** > **Synchronize clocks** in the SnapBridge app  tab.

The smart device and camera are now connected. Any pictures you take with the camera will automatically be uploaded to the smart device.

■ Setup from the Camera Menus

The camera clock can be set manually.

1 Turn the camera on.

A language-selection dialog will be displayed.



Use the multi selector and **OK** button to navigate the menus.

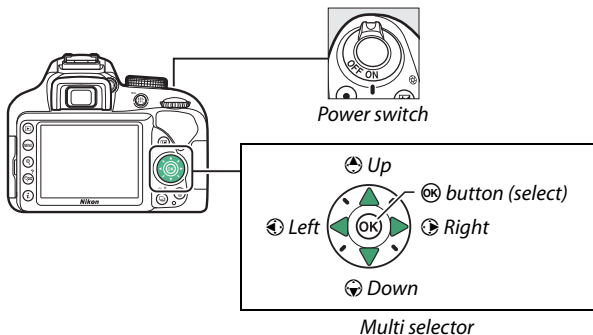

Press **Up** and **Down** to highlight a language and press **OK** to select. The language can be changed at any time using the **Language** option in the setup menu.

2 Press MENU when the dialog at right is displayed.

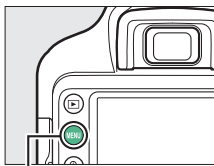

MENU button

3 Set the camera clock.

Use the multi selector and **OK** button to set the camera clock.

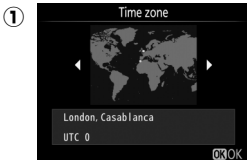

Select time zone



Select date format

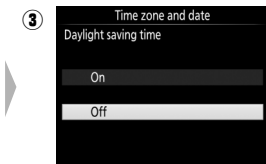

Select daylight saving time option

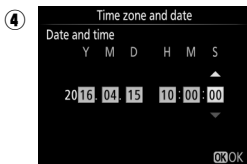

Set time and date (note that the camera uses a 24-hour clock)

The clock can be adjusted at any time using the **Time zone and date > Date and time** option in the setup menu.

Focus the Viewfinder

After removing the lens cap, rotate the diopter adjustment control until the focus points are in sharp focus. When operating the control with your eye to the viewfinder, be careful not to put your fingers or fingernails in your eye.

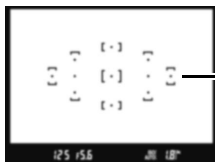
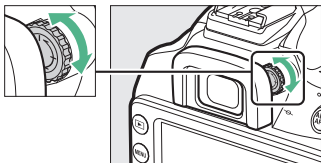

Viewfinder not in focus

Focus points

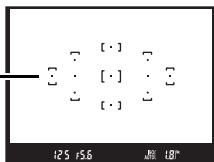

Viewfinder in focus

Tutorial

Camera Menu: An Overview

Most shooting, playback, and setup options can be accessed from the camera menu. To view the menu, press the MENU button.

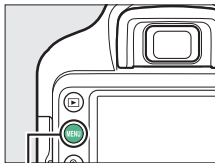

MENU button

Tabs

Choose from the following menus:

- : **Playback** (📖 186)
- : **Shooting** (📖 190)
- : **Setup** (📖 199)
- : **Retouch** (📖 227)
- : **Recent settings** (📖 251)

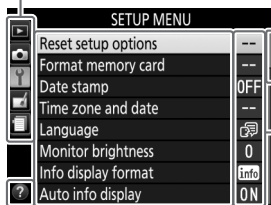

Slider shows position in current menu.

Current settings are shown by icons.

Menu options

Options in current menu.

Help icon (📖 28)

Using Camera Menus

The multi selector and **OK** button are used to navigate the camera menus.

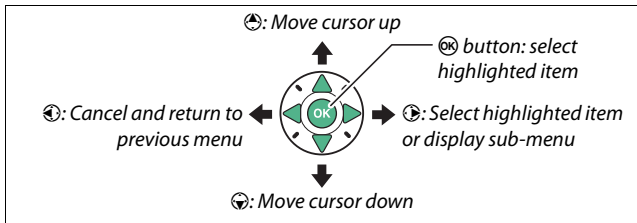

The **?** (Help) Icon

If a **?** icon is displayed at the bottom left corner of the monitor, a description of the currently selected option or menu can be displayed by pressing the **?** button. Press **⬆** or **⬇** to scroll through the display. Press **?** again to return to the menus.

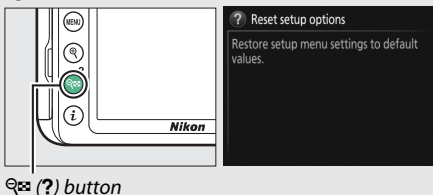

■ Navigating the Menus

Follow the steps below to navigate the menus.

1 Display the menus.

Press the **MENU** button to display the menus.

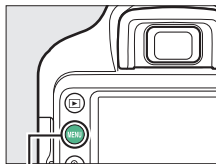

MENU button

2 Highlight the icon for the current menu.

Press  to highlight the icon for the current menu.

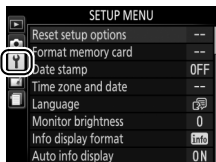

3 Select a menu.

Press  or  to select the desired menu.

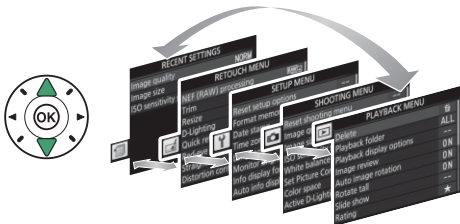

4 Position the cursor in the selected menu.

Press  to position the cursor in the selected menu.

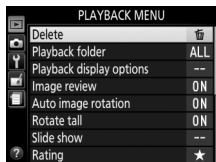

5 Highlight a menu item.

Press or to highlight a menu item.

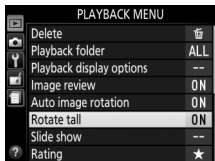

6 Display options.

Press to display options for the selected menu item.

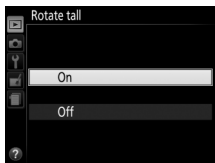

7 Highlight an option.

Press or to highlight an option.

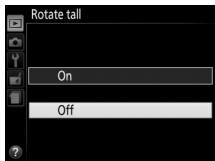

8 Select the highlighted item.

Press to select the highlighted item. To exit without making a selection, press the **MENU** button.



Note the following:

- Menu items that are displayed in gray are not currently available.
- While pressing generally has the same effect as pressing , there are some cases in which selection can only be made by pressing .
- To exit the menus and return to shooting mode, press the shutter-release button halfway (📖 36).

The Battery Level and Number of Exposures Remaining

Press the **info** button and check the battery level and number of exposures remaining in the information display.

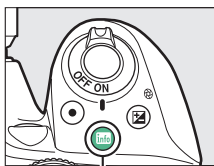

info button



Battery level

Number of exposures remaining

Battery Level

If the battery is low, a warning will also be displayed in the viewfinder. If the information display does not appear when the **info** button is pressed, the battery is exhausted and needs to be recharged.





Information display	Viewfinder	Description
	—	Battery fully charged.
	—	Battery partially discharged.
		Low battery. Ready fully-charged spare battery or prepare to charge battery.
 (flashes)	 (flashes)	Battery exhausted. Charge battery.

Number of Exposures Remaining



Values over 1000 are shown in thousands, indicated by the letter "k".

Basic Photography and Playback

“Point-and-Shoot” Modes (AUTO and)

This section describes how to take photographs in  and  modes.  and  are automatic “point-and-shoot” modes in which the majority of settings are controlled by the camera in response to shooting conditions; the only difference between the two is that the flash will not fire in  mode.



- 1 Rotate the mode dial to  or .

Mode dial

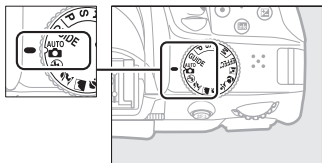

Photographs can be framed in the viewfinder or in the monitor (live view). To start live view, press the  button.

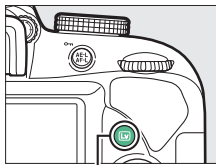

 button



Framing pictures in the viewfinder



Framing pictures in the monitor (live view)

2 Ready the camera.

Viewfinder photography: When framing photographs in the viewfinder, hold the handgrip in your right hand and cradle the camera body or lens with your left. Bring your elbows in against the sides of your chest.



Live view: When framing photographs in the monitor, hold the handgrip in your right hand and cradle the lens with your left.



Framing Photographs in Portrait (Tall) Orientation

When framing photographs in portrait (tall) orientation, hold the camera as shown below.



Framing photographs in the viewfinder



Framing photographs in the monitor

3 Frame the photograph.

Viewfinder photography: Frame a photograph in the viewfinder with the main subject in at least one of the 11 focus points.

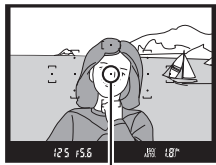

Focus point

Live view: At default settings, the camera automatically detects faces and selects the focus point. If no face is detected, the camera will focus on subjects near the center of the frame.



Focus point

Using a Zoom Lens

Before focusing, rotate the zoom ring to adjust the focal length and frame the photograph. Use the zoom ring to zoom in on the subject so that it fills a larger area of the frame, or zoom out to increase the area visible in the final photograph (select longer focal lengths on the lens focal length scale to zoom in, shorter focal lengths to zoom out).

Zoom in

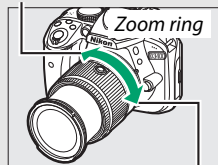

Zoom out

4 Press the shutter-release button halfway.

Viewfinder photography: Press the shutter-release button halfway to focus (if the subject is poorly lit, the flash may pop up and the AF-assist illuminator may light).



In-focus indicator

When the focus operation is complete, a beep will sound (a beep may not sound if the subject is moving) and the in-focus indicator (●) will appear in the viewfinder.

In-focus indicator	Description
●	Subject in focus.
● (flashes)	Camera unable to focus using autofocus. See page 72.

Live view: The focus point flashes green while the camera focuses. If the camera is able to focus, the focus point will be displayed in green; otherwise, the focus point will flash red.



5 Shoot.

Smoothly press the shutter-release button the rest of the way down to take the photograph. The memory card access lamp will light and the photograph will be displayed in the monitor for a few seconds. *Do not eject the memory card or remove or disconnect the power source until the lamp has gone out and recording is complete.*

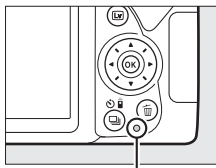

Memory card access lamp



To end live view, press the **Lv** button.

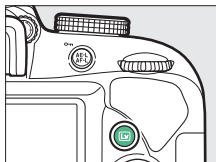

The Shutter-Release Button

The camera has a two-stage shutter-release button. The camera focuses when the shutter-release button is pressed halfway. To take the photograph, press the shutter-release button the rest of the way down.





Focus: press halfway











Shoot: press all the way down

Pressing the shutter-release button halfway also ends playback and readies the camera for immediate use.

✔ Automatic Scene Selection (Scene Auto Selector)

If live view is selected in  or  mode, the camera will automatically analyze the subject and select the appropriate shooting mode when the shutter-release button is pressed halfway to focus using autofocus. The selected mode is shown in the monitor.



	Portrait	Human portrait subjects
	Landscape	Landscapes and cityscapes
	Close up	Subjects close to the camera
	Night portrait	Portrait subjects framed against a dark background
	Auto	Subjects suited to  or  mode or that do not fall into the categories listed above
	Auto (flash off)	

✔ The Standby Timer (Viewfinder Photography)

The viewfinder and information display will turn off if no operations are performed for about eight seconds, reducing the drain on the battery. Press the shutter-release button halfway to reactivate the display. The length of time before the standby timer expires automatically can be selected using the **Auto off timers** option in the setup menu (☞ 207).

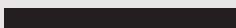

Exposure meters off





Exposure meters on

✔ The Standby Timer (Live View)

The monitor will turn off if no operations are performed for about ten minutes. The length of time before the monitor turns off automatically can be selected using the **Auto off timers** option in the setup menu (☞ 207).

The Built-in Flash

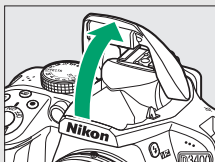

If additional lighting is required for correct exposure in  mode, the built-in flash will pop up automatically when the shutter-release button is pressed halfway (87). If the flash is raised, photographs can only be taken when the flash-ready indicator () is displayed. If the flash-ready indicator is not displayed, the flash is charging; remove your finger briefly from the shutter-release button and try again.

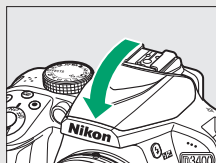

When the flash is not in use, return it to its closed position by pressing it gently downward till the latch clicks into place.



Live View Zoom Preview

To magnify the view in the monitor up to about 8.3 × for precise focus, press the  button. While the view through the lens is zoomed in, a navigation window will appear in a gray frame at the bottom right corner of the display. Use the multi selector to scroll to areas of the frame not visible in the monitor, or press  (?) to zoom out.

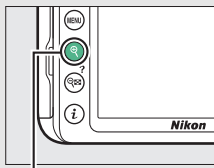

 button



Navigation window

Exposure

Depending on the scene, exposure may differ from that which would be obtained when live view is not used.

Shooting in Live View

Although they will not appear in the final picture, jagged edges, color fringing, moiré, and bright spots may appear in the monitor, while bright regions or bands may appear in some areas with flashing signs and other intermittent light sources or if the subject is briefly illuminated by a strobe or other bright, momentary light source. In addition, distortion may occur with moving subjects, particularly if the camera is panned horizontally or an object moves horizontally at high speed through the frame. Flicker and banding visible in the monitor under fluorescent, mercury vapor, or sodium lamps can be reduced using **Flicker reduction** (☐ 213), although they may still be visible in the final photograph at some shutter speeds. Avoid pointing the camera at the sun or other strong light sources. Failure to observe this precaution could result in damage to the camera's internal circuitry. Live view ends automatically if the mode dial is rotated to **GUIDE** or the mode dial is rotated from **GUIDE** to another setting.

To prevent light entering via the viewfinder from appearing in the photograph or interfering with exposure, we recommend that you cover the viewfinder with your hand or other objects such as an optional eyepiece cap before taking pictures without your eye to the viewfinder (☐ 68).

HDMI

When the camera is attached to an HDMI video device, the video device will display the view through the lens. If the device supports HDMI-CEC, select **Off** for the **HDMI > Device control** option in the setup menu (☐ 185) before shooting in live view.

Basic Playback

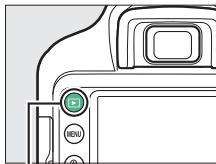

1 Press the button.

A photograph will be displayed in the monitor.



 button

2 View additional pictures.

Additional pictures can be displayed by pressing  or .



To end playback and return to shooting mode, press the shutter-release button halfway.

Deleting Unwanted Photographs

To delete the photograph currently displayed in the monitor, press the  button. *Note that photographs can not be recovered once deleted.*

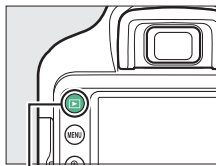

1 Display the photograph.

Display the photograph you wish to delete.



 button

2 Delete the photograph.

Press the  button. A confirmation dialog will be displayed; press the  button again to delete the image and return to playback.

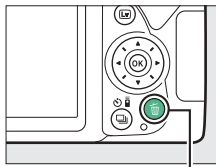

 button



Delete

The **Delete** option in the playback menu can be used to delete multiple images ( 172).



Guide Mode

The Guide

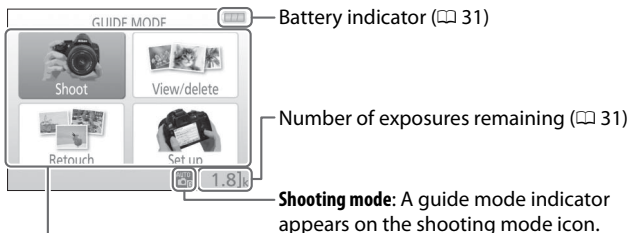
Guide mode gives access to a variety of frequently-used and useful functions. The top level of the guide is displayed when the mode dial is rotated to **GUIDE**.

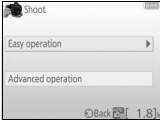
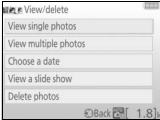

Choose from the following items:

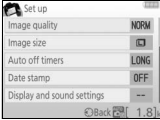
Shoot	View/delete
<p>Take pictures.</p> 	<p>View and/or delete pictures.</p> 
Retouch	Set up
<p>Retouch pictures.</p> 	<p>Change camera settings.</p> 

Guide Mode Menus

To access these menus, highlight **Shoot**, **View/delete**, **Retouch**, or **Set up** and press **OK**.

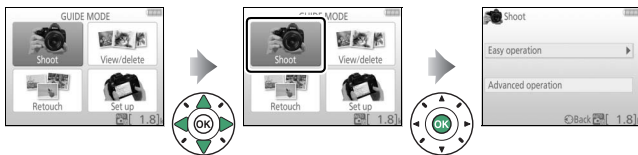

Shoot

Easy operation

	Auto
	No flash
	Distant subjects
	Close-ups
	Sleeping faces
	Moving subjects
	Landscapes
	Portraits
	Night portrait
	Photograph night landscapes

Advanced operation

	Soften backgrounds	Adjust aperture.
	Bring more into focus	
	Freeze motion (people)	Select a shutter speed.
	Freeze motion (vehicles)	
	Show water flowing	
	Capture reds in sunsets*	Adjust white balance to vividly capture the colors in sunsets.
	Take bright photos*	Adjust exposure compensation to take bright (high key) or dark (low key) photos.
	Take dark (low key) photos*	

* Affects other **Advanced operation** items. To restore default settings, turn the camera off and then on again.

“Start Shooting”

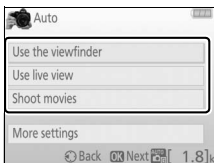

Highlight an option and press **OK**.

- Use the viewfinder
- Use live view
- Shoot movies

“More Settings”

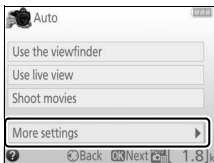

If **More settings** is displayed, you can highlight this option and press **OK** to access the following settings (the settings available vary with the shooting option selected):

- Flash settings > Flash mode
- Flash settings > Flash compensation
- Release mode
- ISO sensitivity settings > ISO sensitivity
- ISO sensitivity settings > Auto ISO sensitivity control
- Set Picture Control
- Exposure compensation
- White balance

■ View/Delete

View single photos

View multiple photos

Choose a date

View a slide show

Delete photos

Guide Mode

Guide mode is reset to **Easy operation > Auto** when the mode dial is rotated to another setting or the camera is turned off.

■ ■ Retouch

Trim

Filter effects (cross screen)

Filter effects (soft)

Photo illustration

Miniature effect

Selective color

■ ■ Set Up

Image quality

Image size

Auto off timers

Date stamp

Display and sound settings

Monitor brightness

Info background color

Auto info display

Beep

Movie settings

Frame size/frame rate

Movie quality

Microphone

Wind noise reduction

Flicker reduction

Playback display options

Clock and language

Format memory card

HDMI

Airplane mode

Smart device connection

Eye-Fi upload *











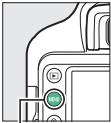







Slot empty release lock

* Only available when compatible Eye-Fi memory card is inserted (□ 224).













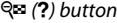

With the exceptions of **Flicker reduction**, **Clock and language**, **Format memory card**, **HDMI**, **Airplane mode**, **Smart device connection**, **Eye-Fi upload**, and **Slot empty release lock**, changes to settings apply in guide mode only and are not reflected in other shooting modes.

Using the Guide

The following operations can be performed while the guide is displayed:

To	Use	Description
Return to top level of guide	 MENU button	Press MENU to turn the monitor on or return to the top level of the guide.
Turn monitor on		
Highlight a menu		Press  ,  ,  , or  to highlight a menu.
Highlight options		Press  ,  ,  , or  to highlight options in the menus.
		Press  ,  ,  , or  to highlight options in displays like that shown below.
Select highlighted menu or option		Press  to select the highlighted menu or option.

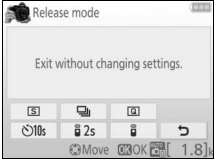

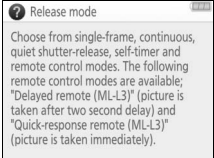

To	Use	Description
Return to previous display		Press  to return to the previous display.
		To cancel and return to the previous display from displays like that shown below, highlight  and press  .
View help	 	<p>If a  icon is displayed at the bottom left corner of the monitor, help can be displayed by pressing the  button. Press  or  to scroll through the display, or press  again to exit.</p>   

Matching Settings to the Subject or Situation (Scene Mode)

The camera offers a choice of “scene” modes. Choosing a scene mode automatically optimizes settings to suit the selected scene, making creative photography as simple as selecting a mode, framing a picture, and shooting as described on page 32.

The following scenes can be selected with the mode dial:



 Portrait	 Sports
 Landscape	 Close up
 Child	 Night Portrait

Portrait



Use for portraits with soft, natural-looking skin tones. If the subject is far from the background or a telephoto lens is used, background details will be softened to lend the composition a sense of depth.

Landscape

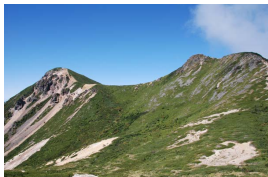

Use for vivid landscape shots in daylight.

Note

The built-in flash and AF-assist illuminator turn off.

Child



Use for snapshots of children. Clothing and background details are vividly rendered, while skin tones remain soft and natural.

Sports



Fast shutter speeds freeze motion for dynamic sports shots in which the main subject stands out clearly.

Note

The built-in flash and AF-assist illuminator turn off.

Close up



Use for close-up shots of flowers, insects, and other small objects (a macro lens can be used to focus at very close ranges).

Night Portrait

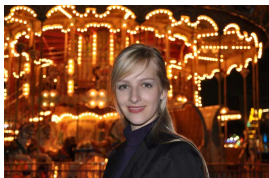

Use for a natural balance between the main subject and the background in portraits taken under low light.

Preventing Blur

Use a tripod to prevent blur caused by camera shake at slow shutter speeds.

Special Effects

Special effects can be used when taking photographs and shooting movies.

The following effects can be selected by rotating the mode dial to **EFFECTS** and rotating the command dial until the desired option appears in the monitor.



Mode dial

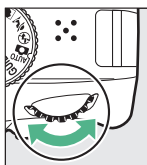

Command dial

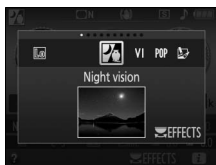

Monitor

 Night Vision

VI Super Vivid

POP Pop

 Photo Illustration

 Toy Camera Effect

 Miniature Effect

 Selective Color

 Silhouette

 High Key

 Low Key

Night Vision

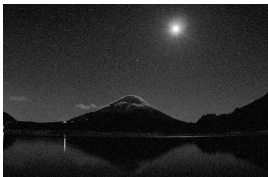

Use under conditions of darkness to record monochrome images at high ISO sensitivities.

Note

Autofocus is available in live view only; manual focus can be used if the camera is unable to focus. The built-in flash and AF-assist illuminator turn off.

Super Vivid



Overall saturation and contrast are increased for a more vibrant image.

POP Pop



Overall saturation is increased for a more lively image.

Photo Illustration



Sharpen outlines and simplify coloring for a poster effect that can be adjusted in live view (☞ 56).

Note

Movies shot in this mode play back like a slide show made up of a series of stills.

Toy Camera Effect



Create photos and movies that appear to have been shot with a toy camera. The effect can be adjusted in live view (☞ 57).

Miniature Effect



Create photos that appear to be pictures of dioramas. Works best when shooting from a high vantage point. Miniature effect movies play back at high speed, compressing about 45 minutes of footage shot at 1920 × 1080/30p into a movie that plays back in about three minutes. The effect can be adjusted in live view (☞ 58).

Note

Sound is not recorded with movies. The built-in flash and AF-assist illuminator turn off.

Selective Color



All colors other than the selected colors are recorded in black and white. The effect can be adjusted in live view (📖 60).

Note

The built-in flash turns off.

Silhouette



Silhouette subjects against bright backgrounds.

Note

The built-in flash turns off.

High Key



Use with bright scenes to create bright images that seem filled with light.

Note

The built-in flash turns off.

Low Key



Use with dark scenes to create dark, low-key images with prominent highlights.





Note

The built-in flash turns off.

Preventing Blur

Use a tripod to prevent blur caused by camera shake at slow shutter speeds.

NEF (RAW)

NEF (RAW) recording is not available in , **VI**, **POP**, , , , and  modes. Pictures taken when an NEF (RAW) or NEF (RAW) + JPEG fine option is selected in these modes will be recorded as JPEG images. JPEG images created at these settings will be recorded as fine-quality images.

and Modes

Autofocus is not available during movie recording. The live view refresh rate will drop, together with the frame rate for continuous release mode; using autofocus during live view photography will disrupt the preview.

Options Available in Live View

Settings for the selected effect are adjusted in the live view display.

■ ■ *Photo Illustration*

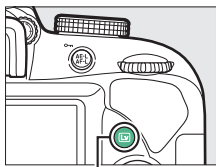

1 Select live view.

Press the  button. The view through the lens will be displayed in the monitor.





 button

2 Adjust outline thickness.

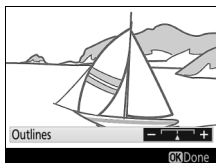
Press  to display the options shown at right. Press  or  to make outlines thicker or thinner.



3 Press .

Press  to exit when settings are complete. To exit live view, press the  button.

1 Select live view.

Press the **Lv** button. The view through the lens will be displayed in the monitor.

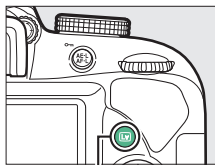

Lv button

2 Adjust options.

Press **OK** to display the options shown at right. Press **▲** or **▼** to highlight **Vividness** or **Vignetting** and press **◀** or **▶** to change. Adjust vividness to make colors more or less saturated, vignetting to control the amount of vignetting.



3 Press **OK.**

Press **OK** to exit when settings are complete. To exit live view, press the **Lv** button.

1 Select live view.

Press the **Lv** button. The view through the lens will be displayed in the monitor.

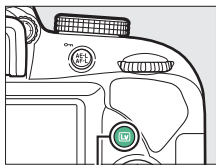

Lv button

2 Position the focus point.

Use the multi selector to position the focus point in the area that will be in focus and then press the shutter-release button halfway to focus. To temporarily clear miniature effect options from the display and enlarge the view in the monitor for precise focus, press **Q**. Press **Q** (?) to restore the miniature effect display.

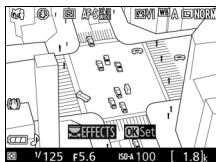



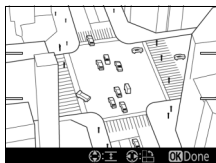

3 Display options.

Press **OK** to display miniature effect options.



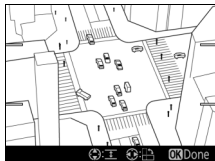

4 Adjust options.

Press  or  to choose the orientation of the area that will be in focus and press  or  to adjust its width.



5 Press .

Press  to exit when settings are complete. To exit live view, press the  button.

1 Select live view.

Press the **Lv** button. The view through the lens will be displayed in the monitor.

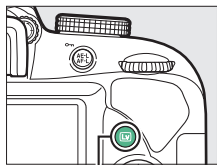

Lv button

2 Display options.

Press **OK** to display selective color options.



**3 Select a color.**

Frame an object in the white square in the center of the display and press **OK** to choose the color of the object as one that will remain in the final image (the camera may have difficulty detecting unsaturated colors; choose a saturated color). To zoom in on the center of the display for more precise color selection, press **OK**. Press **Q** (?) to zoom out.

Selected color





4 Choose the color range.

Press  or  to increase or decrease the range of similar hues that will be included in the final image. Choose from values between 1 and 7; note that higher values may include hues from other colors.

Color range



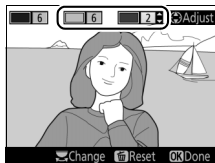

5 Select additional colors.

To select additional colors, rotate the command dial to highlight another of the three color boxes at the top of the display and repeat Steps 3 and 4 to select another color. Repeat for a third color if desired. To deselect the highlighted color, press  (To remove all colors, press and hold . A confirmation dialog will be displayed; select **Yes**).







6 Press .



Press  to exit when settings are complete. During shooting, only objects of the selected hues will be recorded in color; all others will be recorded in black-and-white. To exit live view, press the  button.

More on Photography



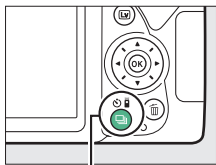

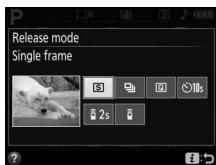

Choosing a Release Mode

To choose how the shutter is released (release mode), press the  () () button, then use the multi selector to highlight the desired option and press .





 () () button



Mode	Description
	Single frame: Camera takes one photograph each time shutter-release button is pressed.
	Continuous: The camera takes photographs while the shutter-release button is pressed (□ 63).
	Quiet shutter release: As for single-frame, except that camera noise is reduced (□ 65).
	Self-timer: Take pictures with the self-timer (□ 66).
 2s	Delayed remote (ML-L3): Shutter is released 2 s after shutter-release button on optional ML-L3 remote control is pressed (□ 95).
	Quick-response remote (ML-L3): Shutter is released when shutter-release button on optional ML-L3 remote control is pressed (□ 95).



Continuous Shooting (Burst Mode)

In  (**Continuous**) mode, the camera takes photographs continuously while the shutter-release button is pressed all the way down.

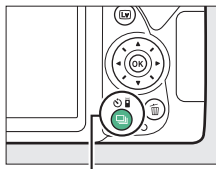
- 1 Press the  () button.



 () button

- 2 Choose  (**Continuous**). Highlight  (**Continuous**) and press .

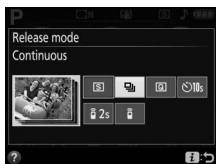

- 3 **Focus.**
Frame the shot and focus.



- 4 **Take photographs.**
The camera will take photographs while the shutter-release button is pressed all the way down.



The Memory Buffer

The camera is equipped with a memory buffer for temporary storage, allowing shooting to continue while photographs are being saved to the memory card. Up to 100 photographs can be taken in succession (an exception is if a shutter speed of 4 seconds or slower is selected in mode **S** or **M**, when there is no limit on the number of shots that can be taken in a single burst). If the battery is exhausted while images remain in the buffer, the shutter release will be disabled and the images transferred to the memory card.

Frame Rate

For information on the number of photographs that can be taken in continuous release mode, see page 296. Frame rates may drop when the memory buffer is full or the battery is low.

The Built-in Flash

Continuous release mode can not be used with the built-in flash; rotate the mode dial to  (□ 32) or turn the flash off (□ 87).



Buffer Size

The approximate number of images that can be stored in the memory buffer at current settings is shown in the viewfinder exposure-count display while the shutter-release button is pressed.





Quiet Shutter Release

Choose this mode to keep camera noise to a minimum. A beep does not sound when the camera focuses.

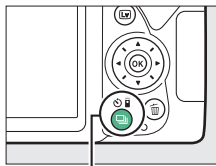
- 1 Press the  (/) button.



 (/) button

- 2 Select  (**Quiet shutter release**).
Highlight  (**Quiet shutter release**)
and press .

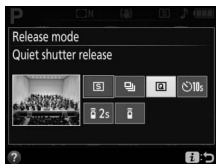

- 3 **Take photographs.**
Press the shutter-release button all
the way down to shoot.



Self-Timer Mode

The self-timer can be used for self-portraits or group shots that include the photographer. Before proceeding, mount the camera on a tripod or place it on a stable, level surface.

- 1 Press the  (Self-timer) button.

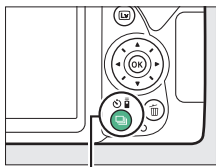

 (Self-timer) button

- 2 Select  (Self-timer) mode.
Highlight  (Self-timer) and press .

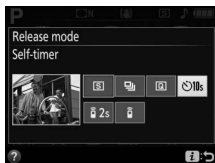

- 3 Frame the photograph.

4 Take the photograph.

Press the shutter-release button halfway to focus, and then press the button the rest of the way down.

The self-timer lamp will start to flash and a beep will

begin to sound. Two seconds before the photo is taken, the lamp will stop flashing and the beeping will become more rapid. The shutter will be released ten seconds after the timer starts.

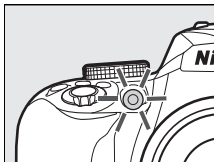



Note that the timer may not start or a photograph may not be taken if the camera is unable to focus or in other situations in which the shutter can not be released. To stop the timer without taking a photograph, turn the camera off.

Cover the Viewfinder

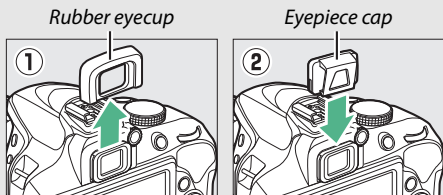
To prevent light entering via the viewfinder from appearing in the photograph or interfering with exposure, we recommend that you cover the viewfinder with your hand or other objects such as an optional eyepiece cap (□ 268) when taking pictures without your eye to the viewfinder. To attach the cap, remove the rubber eyecup (①) and insert the cap as shown (②). Hold the camera firmly when removing the rubber eyecup.



Using the Built-in Flash

Before taking a photograph with the flash in modes that require the flash to be raised manually, press the  (□ 22) button to raise the flash and wait for the  indicator to be displayed in the viewfinder (□ 38). Shooting will be interrupted if the flash is raised after the self-timer has started.

The Setup Menu Self-Timer Option

For information on choosing the duration of the self-timer and the number of shots taken, see the **Self-timer** option in the setup menu (□ 208).

Focus

Focus can be adjusted automatically (see below) or manually (☞ 81). The user can also select the focus point for automatic or manual focus (☞ 76) or use focus lock to focus to recompose photographs after focusing (☞ 79).

Focus Mode

The following focus modes can be selected during viewfinder photography:

Option	Description
AF-A Auto-servo AF	Camera automatically selects single-servo autofocus if subject is stationary, continuous-servo autofocus if subject is moving. Shutter can only be released if camera is able to focus.
AF-S Single-servo AF	For stationary subjects. Focus locks when shutter-release button is pressed halfway. Shutter can only be released if camera is able to focus.
AF-C Continuous-servo AF	For moving subjects. Camera focuses continuously while shutter-release button is pressed halfway. Shutter can only be released if camera is able to focus.
MF Manual focus	Focus manually (☞ 81).

Note that **AF-S** and **AF-C** are available only in modes **P**, **S**, **A**, and **M**.

The following focus modes can be selected during live view:

Option	Description
AF-S Single-servo AF	For stationary subjects. Focus locks when shutter-release button is pressed halfway.
AF-F Full-time-servo AF	For moving subjects. Camera focuses continuously until shutter-release button is pressed. Focus locks when shutter-release button is pressed halfway.
MF Manual focus	Focus manually (☞ 81).

Note that AF-F is not available in , , and  modes.

■ Choosing the Focus Mode

Follow the steps below to choose the focus mode.

1 Display focus mode options.

Press the **i** button, then highlight the current focus mode in the information display and press **OK**.

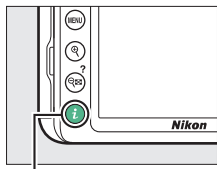

i button

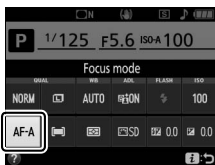

Viewfinder photography

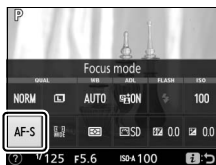

Live view

2 Choose a focus mode.

Highlight a focus mode and press **OK**.



Viewfinder photography



Live view

Predictive Focus Tracking

In **AF-C** mode or when continuous-servo autofocus is selected in **AF-A** mode during viewfinder photography, the camera will initiate predictive focus tracking if the subject moves toward the camera while the shutter-release button is pressed halfway. This allows the camera to track focus while attempting to predict where the subject will be when the shutter is released.

Continuous-Servo Autofocus

In **AF-C** mode or when continuous-servo autofocus is selected in **AF-A** mode, the camera gives higher priority to focus response (has a wider focus range) than in **AF-S** mode, and the shutter may be released before the in-focus indicator is displayed.

Getting Good Results with Autofocus

Autofocus does not perform well under the conditions listed below. The shutter release may be disabled if the camera is unable to focus under these conditions, or the in-focus indicator (●) may be displayed and the camera may sound a beep, allowing the shutter to be released even when the subject is not in focus. In these cases, focus manually (☐ 81) or use focus lock (☐ 79) to focus on another subject at the same distance and then recompose the photograph.



There is little or no contrast between the subject and the background.

Example: Subject is the same color as the background.



The focus point contains objects at different distances from the camera.

Example: Subject is inside a cage.

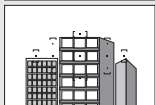

The subject is dominated by regular geometric patterns.

Example: Blinds or a row of windows in a skyscraper.



The focus point contains areas of sharply contrasting brightness.

Example: Subject is half in the shade.



Background objects appear larger than the subject.

Example: A building is in the frame behind the subject.

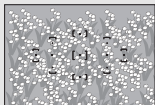

The subject contains many fine details.

Example: A field of flowers or other subjects that are small or lack variation in brightness.

The AF-Assist Illuminator

If the subject is poorly lit, the AF-assist illuminator will light automatically to assist the autofocus operation when the shutter-release button is pressed halfway (some restrictions apply; [□ 284](#)). Note that the illuminator may become hot when used multiple times in quick succession and will turn off automatically to protect the lamp after a period of continuous use. Normal function will resume after a brief pause.

AF-assist illuminator

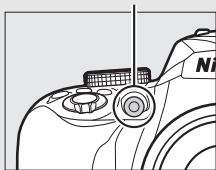

AF-Area Mode



Choose how the focus point for autofocus is selected. The following options are available during viewfinder photography:







Option	Description
[1] Single-point AF	For stationary subjects. Focus point is selected manually; camera focuses on subject in selected focus point only.
[2] Dynamic-area AF	For non-stationary subjects. In AF-A and AF-C focus modes , user selects focus point using multi selector (☐ 76), but camera will focus based on information from surrounding focus points if subject briefly leaves selected point.
[3D] 3D-tracking (11 points)	In AF-A and AF-C focus modes , user selects focus point using multi selector (☐ 76). If subject moves after camera has focused, camera uses 3D-tracking to select new focus point and keep focus locked on original subject while shutter-release button is pressed halfway. 
[] Auto-area AF	Camera automatically detects subject and selects focus point.



Note that [2] (**Dynamic-area AF**) and [3D] (**3D-tracking (11 points)**) AF-area modes are not available when **AF-S** is selected for focus mode.





3D-Tracking (11 Points)

If subject leaves the viewfinder, remove your finger from the shutter-release button and recompose the photograph with the subject in the selected focus point. Note that when the shutter-release button is pressed halfway, the colors in the area surrounding the focus point are stored in the camera. Consequently 3D-tracking may not produce the desired results with subjects that are similar in color to the background or that occupy a very small area of the frame.

In modes other than , , and , the following AF-area modes can be selected in live view:

Option	Description
 Face-priority AF	<p>Use for portraits. The camera automatically detects and focuses on portrait subjects; the selected subject is indicated by a double yellow border (if multiple faces are detected, the camera will focus on the closest subject; to choose a different subject, use the multi selector). If the camera can no longer detect the subject (because, for example, the subject has turned to face away from the camera), the border will no longer be displayed.</p> 
 Wide-area AF	<p>Use for hand-held shots of landscapes and other non-portrait subjects.</p> 
 Normal-area AF	<p>Use for pin-point focus on a selected spot in the frame. A tripod is recommended.</p> 

Option	Description
 Subject-tracking AF	<p>Use the multi selector to position the focus point over your subject and press OK to start tracking. The focus point will track the selected subject as it moves through the frame. To end tracking, press OK again. Note that the camera may be unable to track subjects if they move quickly, leave the frame or are obscured by other objects, change visibly in size, color, or brightness, or are too small, too large, too bright, too dark, or similar in color or brightness to the background.</p> 

Note that subject-tracking AF is not available in , , , and  modes.

Manual Focus-Point Selection

The multi selector can be used to select the focus point. Except in subject-tracking AF, pressing **OK** during focus-point selection selects the center focus point. In subject-tracking AF, pressing **OK** starts subject tracking instead. Manual focus-point selection is not available in auto-area AF.

■ ■ Choosing the AF-Area Mode

Follow the steps below to choose the AF-area mode.

1 Display AF-area mode options.

Press the **i** button, then highlight the current AF-area mode in the information display and press **OK**.

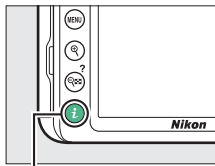

i button



Viewfinder photography

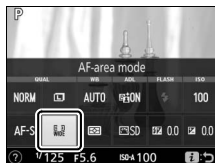

Live view

2 Choose an AF-area mode.

Highlight an option and press **OK**.



Viewfinder photography



Live view

AF-Area Mode

AF-area mode selections made in shooting modes other than **P**, **S**, **A**, or **M** are reset when another shooting mode is selected.

✔ Using Autofocus in Live View

The desired results may not be achieved with teleconverters (☞ 252). Note that in live view, autofocus is slower and the monitor may brighten or darken while the camera focuses. The focus point may sometimes be displayed in green when the camera is unable to focus. The camera may be unable to focus in the following situations:

- The subject contains lines parallel to the long edge of the frame
- The subject lacks contrast
- The subject in the focus point contains areas of sharply contrasting brightness, or includes spot lighting or a neon sign or other light source that changes in brightness
- Flicker or banding appears under fluorescent, mercury-vapor, sodium-vapor, or similar lighting
- A cross (star) filter or other special filter is used
- The subject appears smaller than the focus point
- The subject is dominated by regular geometric patterns (e.g., blinds or a row of windows in a skyscraper)
- The subject is moving

Focus Lock

Focus lock can be used to change the composition after focusing in **AF-A**, **AF-S**, and **AF-C** focus modes (☞ 69), making it possible to focus on a subject that will not be in a focus point in the final composition. If the camera is unable to focus using autofocus (☞ 72), focus lock can also be used to recompose the photograph after focusing on another object at the same distance as your original subject. Focus lock is most effective when an option other than **[] (Auto-area AF)** is selected for AF-area mode (☞ 74).

1 Focus.

Position the subject in the selected focus point and press the shutter-release button halfway to initiate focus. Check that the in-focus indicator (●) appears in the viewfinder (viewfinder photography) or that the focus point has turned green (live view).



Viewfinder photography



Live view

Autoexposure Lock

Pressing the **AE-L/AF-L (O) (M)** button in Step 2 also locks exposure (☞ 113).

2 Lock focus.

AF-A and AF-C focus modes (viewfinder photography): With the shutter-release button pressed halfway (①), press the AE-L/AF-L (●) button (②) to lock focus. Focus will remain locked while the AE-L/AF-L (●) button is pressed, even if you later remove your finger from the shutter-release button.

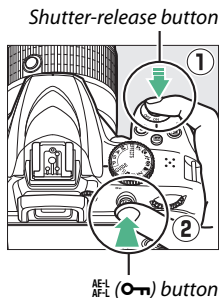

AF-S (viewfinder photography) and live view: Focus locks automatically and remain locked until you remove your finger from the shutter-release button. Focus can also be locked by pressing the AE-L/AF-L (●) button (see above).

3 Recompose the photograph and shoot.

Focus will remain locked between shots if you keep the shutter-release button pressed halfway (AF-S) or keep the AE-L/AF-L (●) button pressed, allowing several photographs in succession to be taken at the same focus setting.



Do not change the distance between the camera and the subject while focus lock is in effect. If the subject moves, focus again at the new distance.

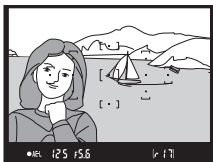

Viewfinder photography



Live view

Manual Focus

Manual focus can be used when autofocus is not available or does not produce the desired results (📖 72).

1 Select manual focus.

If the lens is equipped with an A-M, M/A-M, or A/M-M mode switch, slide the switch to **M**.

A-M mode switch



M/A-M mode switch



If the lens is not equipped with a focus-mode switch, select **MF** (manual focus) for **Focus mode** (📖 69).

2 Focus.

To focus manually, adjust the lens focus ring until the image displayed on the clear matte field in the viewfinder is in focus. Photographs can be taken at any time, even when the image is not in focus.

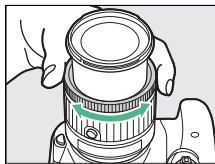

✓ AF-P Lenses

When an AF-P lens (📖 252) is used in manual focus mode, the in-focus indicator (●) will flash in the viewfinder (or in live view, the focus point will flash in the monitor) to warn that continuing to rotate the focus ring in the current direction will not bring the subject into focus.

■ The Electronic Rangefinder (Viewfinder Photography)

The viewfinder focus indicator can be used to confirm whether the subject in the selected focus point is in focus (the focus point can be selected from any of the 11 focus points). After positioning the subject in the selected focus point, press the shutter-release button halfway and rotate the lens focus ring until the in-focus indicator (●) is displayed. Note that with the subjects listed on page 72, the in-focus indicator may sometimes be displayed when the subject is not in focus; confirm focus in the viewfinder before shooting.



✔ Selecting Manual Focus with the Camera

If the lens supports M/A (autofocus with manual override) or A/M (autofocus with manual override/AF priority), manual focus can also be selected by setting the camera focus mode to **MF** (manual focus; □ 69). Focus can then be adjusted manually, regardless of the mode selected with the lens.

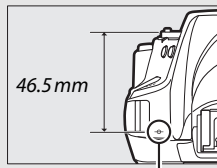

✔ Focal Plane Position

To determine the distance between your subject and the camera, measure from the focal plane mark (⊖) on the camera body. The distance between the lens mounting flange and the focal plane is 46.5 mm (1.83 in.).



Focal plane mark

Live View

Press the  button to zoom in for precise focus in live view ( 38).

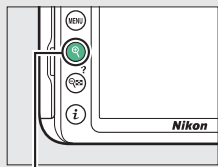

 button

Image Quality and Size

Together, image quality and size determine how much space each photograph occupies on the memory card. Larger, higher quality images can be printed at larger sizes but also require more memory, meaning that fewer such images can be stored on the memory card (□ 323).

Image Quality

Choose a file format and compression ratio (image quality).

Option	File type	Description
NEF (RAW) + JPEG fine	NEF/JPEG	Two images are recorded: one NEF (RAW) image and one fine-quality JPEG image.
NEF (RAW)	NEF	Raw data from the image sensor are saved directly to the memory card. Settings such as white balance and contrast can be adjusted after shooting.
JPEG fine	JPEG	Record JPEG images at a compression ratio of roughly 1 : 4 (fine quality).
JPEG normal		Record JPEG images at a compression ratio of roughly 1 : 8 (normal quality).
JPEG basic		Record JPEG images at a compression ratio of roughly 1 : 16 (basic quality).

NEF (RAW) + JPEG

When photographs taken at **NEF (RAW) + JPEG fine** are viewed on the camera, only the JPEG image will be displayed. When photographs taken at these settings are deleted, both NEF and JPEG images will be deleted.

- 1 Display image quality options.**
Press the **i** button, then highlight the current image quality in the information display and press **OK**.

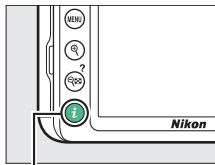

i button



- 2 Choose a file type.**
Highlight an option and press **OK**.



NEF (RAW) Images

Selecting **NEF (RAW)** for **Image quality** fixes **Image size** at **Large** (86). **Date stamp** (202) is not available at image quality settings of NEF (RAW) or NEF (RAW)+JPEG fine.

Converting NEF (RAW) Images to Other Formats

JPEG copies of NEF (RAW) images can be created using the **NEF (RAW) processing** option in the retouch menu (230) or software such as Capture NX-D (177).

Image Size

Image size is measured in pixels. Choose from **L** Large, **M** Medium, or **S** Small:

Image size	Size (pixels)	Print size (cm/in.) *
L Large	6000 × 4000	50.8 × 33.9/20 × 13.3
M Medium	4496 × 3000	38.1 × 25.4/15.0 × 10
S Small	2992 × 2000	25.3 × 16.9/10 × 6.7

* Approximate size when printed at 300 dpi. Print size in inches equals image size in pixels divided by printer resolution in dots per inch (dpi; 1 inch = approximately 2.54 cm).

- 1 Display image size options.**
Press the **i** button, then highlight the current image size in the information display and press **OK**.

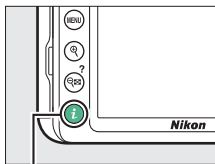

i button





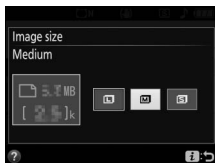





- 2 Choose an image size.**
Highlight an option and press **OK**.





Using the Built-in Flash

The camera supports a variety of flash modes for photographing poorly lit or backlit subjects.



Auto Pop-up Modes

In , , , , , , **POP**, , and  modes, the built-in flash automatically pops up and fires as required.

1 Choose a flash mode.

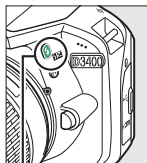
Keeping the  () button pressed, rotate the command dial until the desired flash mode appears in the information display.



 () button

+

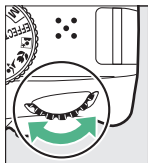

Command dial

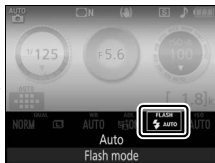

Information display

2 Take photographs.



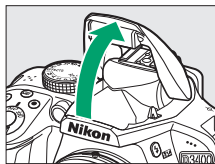

The flash will pop up as required when the shutter-release button is pressed halfway, and fire when a photograph is taken. *If the flash does not pop up*

automatically, DO NOT attempt to raise it by hand. Failure to observe this precaution could damage the flash.



Flash Modes

The following flash modes are available:

- **⚡ AUTO** (auto): When lighting is poor or the subject is backlit, the flash pops up automatically when the shutter-release button is pressed halfway and fires as required. Not available in  mode.
- **⚡👁️ AUTO** (auto + red-eye reduction): Use for portraits. The flash pops up and fires as required, but before it fires the red-eye reduction lamp lights to help reduce “red-eye.” Not available in  mode.
- **⚡👁️ AUTO SLOW** (auto slow sync + red-eye): As for auto with red-eye reduction, except that slow shutter speeds are used to capture background lighting. Use for portraits taken at night or under low light. Available in  mode.
- **⚡ AUTO SLOW** (auto slow sync): Slow shutter speeds are used to capture background lighting in shots taken at night or under low light. Available in  mode.
- **🔕** (flash off): The flash does not fire.

The Information Display

Flash mode can also be selected in the information display.

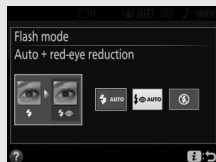



Manual Pop-up Modes

In P, S, A, and M modes, the flash must be raised manually. The flash will not fire if it is not raised.

1 Raise the flash.

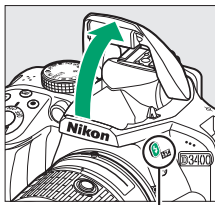
Press the  button to raise the flash.



 button

2 Choose a flash mode.

Keeping the  button pressed, rotate the command dial until the desired flash mode appears in the information display.

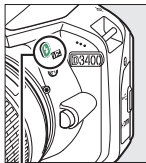

 button

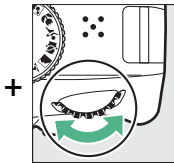

Command dial



Information display

3 Take photographs.

The flash will fire whenever a picture is taken.

■ Flash Modes

The following flash modes are available:

- **⚡** (fill flash): The flash fires with every shot.
- **⚡👁** (red-eye reduction): Use for portraits. The flash fires with every shot, but before it fires, the red-eye reduction lamp lights to help reduce “red-eye.”
- **⚡👁SLOW** (slow sync + red-eye): As for “red-eye reduction”, above, except that shutter speed slows automatically to capture background lighting at night or under low light. Use when you want to include background lighting in portraits. Not available in modes **S** and **M**.
- **⚡SLOW** (slow sync): As for “fill flash”, above, except that shutter speed slows automatically to capture background lighting at night or under low light. Use when you want to capture both subject and background. Not available in modes **S** and **M**.
- **⚡SLOW REAR** (rear curtain + slow sync): As for “rear-curtain sync”, below, except that shutter speed slows automatically to capture background lighting at night or under low light. Use when you want to capture both subject and background. Not available in modes **S** and **M**.
- **⚡REAR** (rear-curtain sync): The flash fires just before the shutter closes, creating a stream of light behind moving light sources as shown below at right. Not available in modes **P** and **A**.



Front-curtain sync



Rear-curtain sync

Lowering the Built-in Flash

To save power when the flash is not in use, press it gently downward until the latch clicks into place.

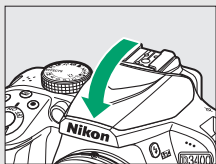

The Built-in Flash

For information on the lenses that can be used with the built-in flash, see page 258. Remove lens hoods to prevent shadows. The flash has a minimum range of 0.6 m (2 ft) and can not be used in the macro range of zoom lenses with a macro function.

The shutter release may be briefly disabled to protect the flash after it has been used for several consecutive shots. The flash can be used again after a short pause.

Shutter Speeds Available with the Built-in Flash

Shutter speed is restricted to the following ranges when the built-in flash is used:

Mode	Shutter speed
AUTO, , , , , VI, POP, , , P, A	$\frac{1}{200}$ – $\frac{1}{60}$ s
	$\frac{1}{200}$ –1 s
S	$\frac{1}{200}$ –30 s
M	$\frac{1}{200}$ –30 s, Bulb, Time



Aperture, Sensitivity, and Flash Range

Flash range varies with sensitivity (ISO equivalency) and aperture.

Aperture at ISO equivalent of							Approximate range	
100	200	400	800	1600	3200	6400	m	ft
1.4	2	2.8	4	5.6	8	11	1.0–6.0	3ft 4in.–19ft 8in.
2	2.8	4	5.6	8	11	—	0.7–4.2	2ft 4in.–13ft 9in.
2.8	4	5.6	8	11	—	—	0.6–3.0	2ft–9ft 10in.
4	5.6	8	11	—	—	—	0.6–2.1	2ft–6ft 10in.
5.6	8	11	—	—	—	—	0.6–1.5	2ft–4ft 11in.
8	11	—	—	—	—	—	0.6–1.1	2ft–3ft 7in.
11	—	—	—	—	—	—	0.6–0.7	2ft–2ft 4in.

ISO Sensitivity

The camera's sensitivity to light can be adjusted according to the amount of light available. The higher the ISO sensitivity, the less light needed to make an exposure, allowing higher shutter speeds or smaller apertures. Choosing **Auto** allows the camera to set ISO sensitivity automatically in response to lighting conditions; to use auto in **P**, **S**, **A**, and **M** modes, select **Auto ISO sensitivity control** for the **ISO sensitivity settings** item in the shooting menu (☞ 193).

Mode	ISO sensitivity
AUTO,  , 	Auto
P , S , A , M	100–25600 in steps of 1 EV
Other shooting modes	Auto; 100–25600 in steps of 1 EV

1 Display ISO sensitivity options.

Press the **i** button, then highlight the current ISO sensitivity in the information display and press **OK**.

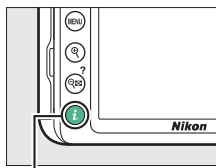

i button



-
- 2** Choose an ISO sensitivity.
Highlight an option and press **OK**.

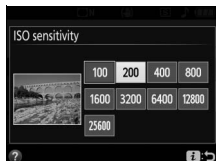



Remote Control Photography

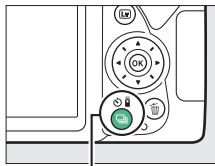

Using an Optional ML-L3 Remote Control

The optional ML-L3 remote control (📖 269) can be used to reduce camera shake or for self-portraits. Before proceeding, mount the camera on a tripod or place it on a stable, level surface.

- 1 Press the  (🌙/📷) button.



 (🌙/📷) button

- 2 Select a remote control mode. Highlight  2s (**Delayed remote (ML-L3)**) or  (**Quick-response remote (ML-L3)**) and press .

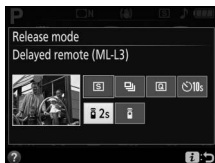

3 Frame the photograph.

Check focus by pressing the shutter-release button halfway.



4 Take the photograph.

From a distance of 5 m (16 ft) or less, aim the transmitter on the ML-L3 at the infrared receiver on the camera (📖 2) and press the ML-L3 shutter-release button. *In delayed remote mode*, the self-timer lamp will light for about two seconds before the shutter is released. *In quick-response remote mode*, the self-timer lamp will flash after the shutter has been released.

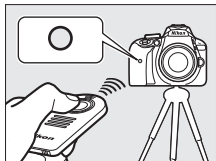

Note that the timer may not start or a photograph may not be taken if the camera is unable to focus or in other situations in which the shutter can not be released.

Before Using the ML-L3 Remote Control

Before using the ML-L3 for the first time, remove the clear plastic battery-insulator sheet.

Cover the Viewfinder

To prevent light entering via the viewfinder from appearing in the photograph or interfering with exposure, we recommend that you cover the viewfinder with an optional eyepiece cap (📖 268) before taking pictures without your eye to the viewfinder (📖 68).



✔ The Camera Shutter-Release Button

If an ML-L3 remote release mode is selected and the shutter is released by pressing the camera shutter-release button, the camera will function in single-frame release mode.

✔ Exiting Remote Control Mode

Remote control mode is cancelled automatically if no photograph is taken before the time selected for the **Remote on duration (ML-L3)** option in the setup menu (□ 208). Remote control mode will also be cancelled if the camera is turned off or shooting options are reset using **Reset shooting menu**.

✔ Using the Built-in Flash

Before taking a photograph with the flash in manual pop-up modes (□ 89), press the  () button to raise the flash and wait for the  indicator to be displayed in the viewfinder (□ 38). Shooting will be interrupted if the flash is raised after the shutter-release button on the ML-L3 is pressed. If the flash is required, the camera will only respond to the ML-L3 shutter-release button once the flash has charged. In auto pop-up modes, the flash will begin charging when a remote control mode is selected; once the flash is charged, it will automatically pop up and fire when required.

P, S, A, and M Modes

Shutter Speed and Aperture

P, S, A, and M modes offer different degrees of control over shutter speed and aperture:



Mode		Description
P	Programmed auto (☞ 99)	Recommended for snapshots and in other situations in which there is little time to adjust camera settings. Camera sets shutter speed and aperture for optimal exposure.
S	Shutter-priority auto (☞ 101)	Use to freeze or blur motion. User chooses shutter speed; camera selects aperture for best results.
A	Aperture-priority auto (☞ 103)	Use to blur background or bring both foreground and background into focus. User chooses aperture; camera selects shutter speed for best results.
M	Manual (☞ 105)	User controls both shutter speed and aperture. Set shutter speed to "Bulb" or "Time" for long time-exposures.

Mode P (Programmed Auto)

This mode is recommended for snapshots or whenever you want to leave the camera in charge of shutter speed and aperture. The camera automatically adjusts shutter speed and aperture for optimal exposure in most situations.

Mode dial

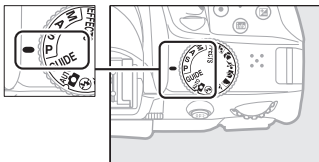

To take pictures in programmed auto mode, rotate the mode dial to **P**.

Flexible Program

In mode **P**, different combinations of shutter speed and aperture can be selected by rotating the command dial (“flexible program”). Rotate the dial right for large apertures (low f-numbers) and fast shutter speeds, left for small apertures (high f-numbers) and slow shutter speeds. All combinations produce the same exposure.

Rotate right to blur background details or freeze motion.

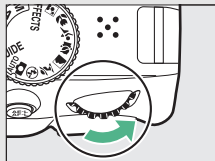

Command dial

Rotate left to increase depth of field or blur motion.

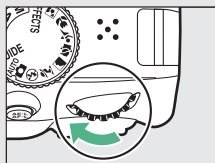

While flexible program is in effect, a  (**P**) indicator appears in the viewfinder and information display. To restore default shutter speed and aperture settings, rotate the command dial until the indicator is no longer displayed, choose another mode, or turn the camera off.



Mode S (Shutter-Priority Auto)

This mode lets you control shutter speed: choose fast shutter speeds to “freeze” motion, slow shutter speeds to suggest motion by blurring moving objects. The camera automatically adjusts aperture for optimal exposure.



Fast shutter speeds (e.g., $1/1600$ s) freeze motion.

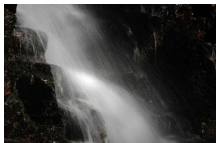

Slow shutter speeds (e.g., 1 s) blur motion.

To choose a shutter speed:

1 Rotate the mode dial to S.

Mode dial

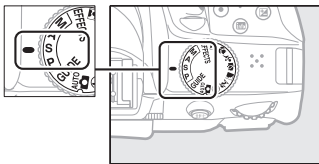

Mode A (Aperture-Priority Auto)

In this mode, you can adjust aperture to control depth of field (the distance in front of and behind the main subject that appears to be in focus). The camera automatically adjusts shutter speed for optimal exposure.



Large apertures (low f-numbers, e.g. f/5.6) blur details in front of and behind the main subject.



Small apertures (high f-numbers, e.g. f/22) bring the foreground and background into focus.

To choose an aperture:

1 Rotate the mode dial to A.

Mode dial

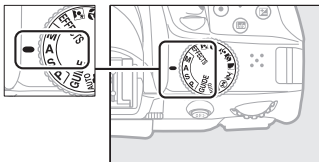

2 Choose an aperture.

Rotate the command dial left for larger apertures (lower f-numbers), right for smaller apertures (higher f-numbers).

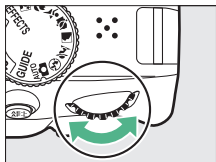

Command dial

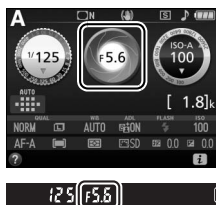

Mode M (Manual)

In manual mode, you control both shutter speed and aperture. Shutter speeds of “Bulb” and “Time” are available for long time-exposures of moving lights, the stars, night scenery, or fireworks (📖 107).

- 1 Rotate the mode dial to M.** *Mode dial*

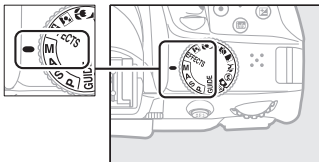

2 Choose aperture and shutter speed.

Checking the exposure indicator (see below), adjust shutter speed and aperture. Shutter speed is selected by rotating the command dial (right for faster speeds, left for slower). To adjust aperture, keep the  button pressed while rotating the command dial (left for larger apertures/lower f-numbers and right for smaller apertures/higher f-numbers).

Shutter speed

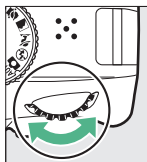

Command dial

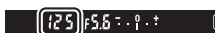

Aperture

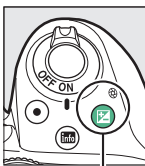

 button

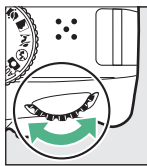



Command dial



The Exposure Indicator

If a type E or G lens is attached (□ 252) and a shutter speed other than “Bulb” or “Time” is selected (□ 107), the exposure indicator in the viewfinder and information display shows whether the photograph would be under- or over-exposed at current settings.

Optimal exposure	Underexposed by 1/3 EV	Overexposed by over 2 EV
		

Long Time-Exposures (M Mode Only)

Select the following shutter speeds for long time-exposures of moving lights, the stars, night scenery, or fireworks.

- **Bulb** (b): The shutter remains open while the shutter-release button is pressed all the way down. Use a tripod to prevent blur.
- **Time** (- -): Start the exposure using the shutter-release button on the camera or on an optional remote control. The shutter remains open for thirty minutes or until the button is pressed a second time.



*Length of exposure: 35 s
Aperture: f/25*

Before proceeding, mount the camera on a tripod or place it on a stable, level surface. To prevent light entering via the viewfinder from appearing in the photograph or interfering with exposure, we recommend that you cover the viewfinder with your hand or other objects such as an optional eyepiece cap (□ 268) before taking pictures without your eye to the viewfinder (□ 68). To prevent loss of power before the exposure is complete, use a fully charged battery. Note that noise (bright spots, randomly-spaced bright pixels, or fog) may be present in long exposures.

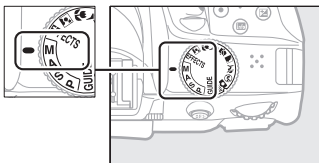
1 Rotate the mode dial to M. *Mode dial*

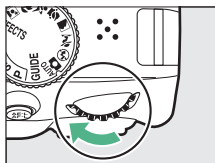
2 Choose the shutter speed.
Rotate the command dial left to choose a shutter speed of “Time” (- -).*Command dial*





3 Open the shutter.

After focusing, press the shutter-release button on the camera or optional remote control all the way down.

4 Close the shutter.

Repeat the operation performed in Step 3.

ML-L3 Remote Controls

If you will be using an ML-L3 remote control, select one of the following remote control modes as described on page 95:  2s (**Delayed remote (ML-L3)**) or  (**Quick-response remote (ML-L3)**). Note that pictures will be taken in “Time” mode even when “Bulb”/  is selected for shutter speed. The exposure starts when the shutter-release button on the remote control is pressed and ends after 30 minutes or when the button is pressed again.

Exposure

Metering

Choose how the camera sets exposure.

Method	Description
<input checked="" type="checkbox"/> Matrix metering	Produces natural results in most situations. The camera meters a wide area of the frame and sets exposure according to tone distribution, color, composition, and distance.
<input checked="" type="checkbox"/> Center-weighted metering	Classic meter for portraits. Camera meters entire frame but assigns greatest weight to center area. Recommended when using filters with an exposure factor (filter factor) over 1x.
<input type="checkbox"/> Spot metering	Choose this mode to ensure that subject will be correctly exposed, even when background is much brighter or darker. Camera meters current focus point; use to meter off-center subjects.

- 1 Display metering options.**
Press the **i** button, then highlight the current metering method in the information display and press **OK**.

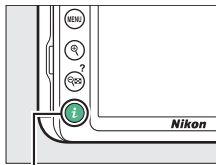

i button

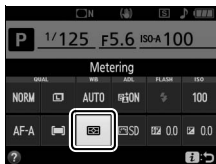



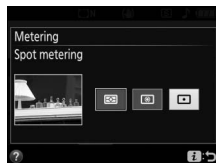

- 2 Choose a metering method.**
Highlight an option and press **OK**.



Spot Metering

If **[]** (Auto-area AF) is selected for **AF-area mode** during viewfinder photography (□ 74), the camera will meter the center focus point.

Autoexposure Lock

Use autoexposure lock to recompose photographs after using  (**Center-weighted metering**) and  (**Spot metering**) to meter exposure; note that autoexposure lock is not available in  or  mode.

1 Lock exposure.

Position the subject in the selected focus point and press the shutter-release button halfway. With the shutter-release button pressed halfway and the subject positioned in the focus point, press the  (**AE-L/AF-L**) button to lock exposure.

Shutter-release button

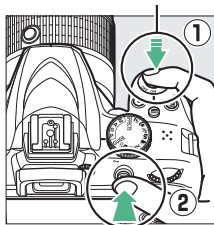

 button

While exposure lock is in effect, an **AE-L** indicator will appear in the viewfinder and the monitor.



2 Recompose the photograph.

Keeping the $\text{AE-L}/\text{AF-L}$ (O) button pressed, re-compose the photograph and shoot.





Adjusting Shutter Speed and Aperture

While exposure lock is in effect, the following settings can be adjusted without altering the metered value for exposure:

Mode	Setting
Programmed auto	Shutter speed and aperture (flexible program; \square 100)
Shutter-priority auto	Shutter speed
Aperture-priority auto	Aperture

The metering method itself can not be changed while exposure lock is in effect.

Exposure Compensation

Exposure compensation is used to alter exposure from the value suggested by the camera, making pictures brighter or darker (📖 297). In general, positive values make the subject brighter while negative values make it darker. It is most effective when used with  (**Center-weighted metering**) or  (**Spot metering**) (📖 111).



-1 EV





*No exposure
compensation*

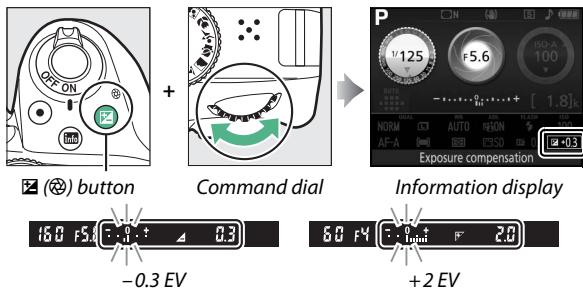

+1 EV

To choose a value for exposure compensation, keep the  button pressed and rotate the command dial until the desired value is selected in the viewfinder or information display.



Normal exposure can be restored by setting exposure compensation to ± 0 . In **P**, **S**, **A**, and **M** modes, exposure compensation is not reset when the camera is turned off. In scene and  modes, exposure compensation will be reset when another mode is selected or the camera is turned off.

The Information Display

Exposure compensation options can also be accessed from the information display (□ 11).

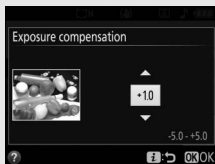

Mode M





In mode **M**, exposure compensation affects only the exposure indicator.



Using a Flash

When a flash is used, exposure compensation affects both background exposure and flash level.

Flash Compensation

Flash compensation is used to alter flash output from the level suggested by the camera, changing the brightness of the main subject relative to the background. Flash output can be increased to make the main subject appear brighter, or reduced to prevent unwanted highlights or reflections (□ 299).

Keep the  () and  () buttons pressed and rotate the command dial until the desired value is selected in the viewfinder or information display. In general, positive values make the main subject seem brighter while negative values make it seem darker. Normal flash output can be restored by setting flash compensation to ± 0 . Flash compensation is not reset when the camera is turned off (in scene mode, flash compensation will be reset when another mode is selected or the camera is turned off).

 () button

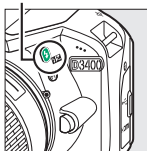

+

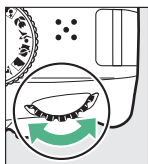



Command dial



Information display



 () button



-0.3 EV



+1 EV

The Information Display

Flash compensation options can also be accessed from the information display (11).

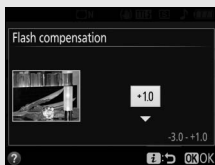



Optional Flash Units

Flash compensation is also available with optional flash units that support the Nikon Creative Lighting System (CLS; see page 262). The flash compensation selected with the optional flash unit is added to the flash compensation selected with the camera.

Preserving Detail in Highlights and Shadows

Active D-Lighting

Active D-Lighting preserves details in highlights and shadows, creating photographs with natural contrast. Use for high contrast scenes, for example when photographing brightly lit outdoor scenery through a door or window or taking pictures of shaded subjects on a sunny day. Active D-Lighting is not recommended in mode **M**; in other modes, it is most effective when used with  (**Matrix metering**;  111).

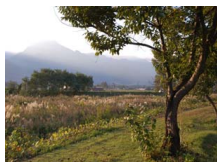

Active D-Lighting: **Off**



Active D-Lighting: **On**

- 1 Display Active D-Lighting options.**
Press the **i** button, then highlight Active D-Lighting in the information display and press **OK**.

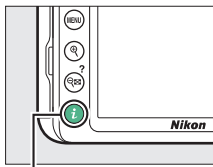

i button



- 2 Choose an option.**
Highlight **On** or **Off** and press **OK**.



✓ Active D-Lighting







With some subjects, you may notice uneven shading, shadows around bright objects, or halos around dark objects. Active D-Lighting is not available with movies.

✎ "Active D-Lighting" Versus "D-Lighting"

Active D-Lighting adjusts exposure before shooting to optimize the dynamic range, while the **D-Lighting** option in the retouch menu (🗨 235) brightens shadows in images after shooting.

White Balance

White balance ensures that colors are unaffected by the color of the light source. Auto white balance is recommended for most light sources; other values can be selected if necessary according to the type of source:

Option	Description
AUTO Auto	Automatic white balance adjustment. Recommended in most situations.
 Incandescent	Use under incandescent lighting.
 Fluorescent	Use with the light sources listed on page 123.
 Direct sunlight	Use with subjects lit by direct sunlight.
 Flash	Use with the flash.
 Cloudy	Use in daylight under overcast skies.
 Shade	Use in daylight with subjects in the shade.
PRE Preset manual	Measure white balance or copy white balance from existing photo (☞ 126).

- 1 Display white balance options.**
Press the **i** button, then highlight the current white balance setting in the information display and press **OK**.

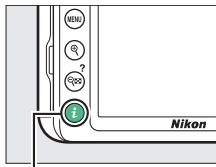

i button



- 2 Choose a white balance option.**
Highlight an option and press **OK**.

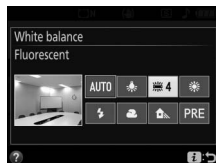

The Shooting Menu





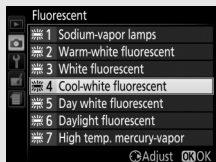
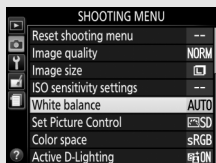







White balance can be selected using the **White balance** option in the shooting menu (☰ 190), which also can be used to fine-tune white balance (☰ 124) or measure a value for preset white balance (☰ 126).

The  **Fluorescent** option in the **White balance** menu can be used to select the light source from the bulb types shown at right.



Color Temperature

The perceived color of a light source varies with the viewer and other conditions. Color temperature is an objective measure of the color of a light source, defined with reference to the temperature to which an object would have to be heated to radiate light in the same wavelengths. While light sources with a color temperature in the neighborhood of 5000–5500 K appear white, light sources with a lower color temperature, such as incandescent light bulbs, appear slightly yellow or red. Light sources with a higher color temperature appear tinged with blue. The camera white balance options are adapted to the following color temperatures (all figures are approximate):

-  (sodium-vapor lamps): **2700 K**
-  (incandescent)/
•  (warm-white fluorescent):
3000 K
-  (white fluorescent): **3700 K**
-  (cool-white fluorescent):
4200 K
-  (day white fluorescent): **5000 K**
-  (direct sunlight): **5200 K**
-  (flash): **5400 K**
-  (cloudy): **6000 K**
-  (daylight fluorescent): **6500 K**
-  (high temp. mercury-vapor):
7200 K
-  (shade): **8000 K**

Fine-Tuning White Balance

White balance can be “fine-tuned” to compensate for variations in the color of the light source or to introduce a deliberate color cast into an image. White balance is fine-tuned using the **White balance** option in the shooting menu.

1 Display fine-tuning options.

Highlight a white balance option and press \odot (if **Fluorescent** is selected, highlight the desired lighting type and press \odot); note that fine-tuning is not available with **Preset manual**).

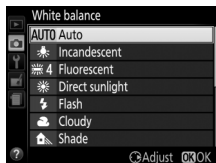

2 Fine-tune white balance.

Use the multi selector to fine-tune white balance. White balance can be fine-tuned on the amber (A)–blue (B) axis in steps of 0.5 and the green (G)–magenta (M) axis in steps of 0.25. The horizontal (amber-blue) axis corresponds to color temperature, while the vertical (green-magenta) axis has effects similar to those achieved with the corresponding color compensation (CC) filters. The horizontal axis is ruled in increments equivalent to about 5 mired, the vertical axis in increments of about 0.05 diffuse density units.

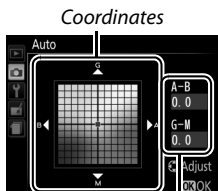

3 Save changes and exit.

Press \odot .

White Balance Fine-Tuning

The colors on the fine-tuning axes are relative, not absolute. For example, moving the cursor to **B** (blue) when a “warm” setting such as  (incandescent) is selected will make photographs slightly “colder” but will not actually make them blue.

“Mired”

Any given change in color temperature produces a greater difference in color at low color temperatures than it would at higher color temperatures. For example, a change of 1000 K produces a much greater change in color at 3000 K than at 6000 K. Mired, calculated by multiplying the inverse of the color temperature by 10^6 , is a measure of color temperature that takes such variation into account, and as such is the unit used in color-temperature compensation filters. E.g.:

- 4000 K–3000 K (a difference of 1000 K)=83 mired
- 7000 K–6000 K (a difference of 1000 K)=24 mired

Preset Manual

Preset manual is used to record and recall custom white balance settings for shooting under mixed lighting or to compensate for light sources with a strong color cast. Two methods are available for setting preset white balance:



Method	Description
Measure	Neutral gray or white object is placed under lighting that will be used in final photo and white balance measured by camera (see below).
Use photo	White balance is copied from photo on memory card (📄 130).

■ Measuring a Value for Preset White Balance

1 Light a reference object.

Place a neutral gray or white object under the lighting that will be used in the final photograph.

2 Display white balance options.

Highlight **White balance** in the shooting menu and press  to display white balance options. Highlight **Preset manual** and press .

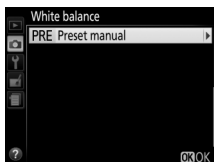

3 Select Measure.

Highlight **Measure** and press .

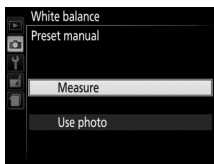

4 Select Yes.

The menu shown at right will be displayed; highlight **Yes** and press **OK**.



The camera will enter preset measurement mode.

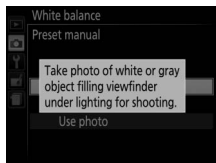

When the camera is ready to measure white balance, a flashing **P_rE** (PRE) will appear in the viewfinder and information display.



5 Measure white balance.

Before the indicators stop flashing, frame the reference object so that it fills the viewfinder and press the shutter-release button all the way down. No photograph will be recorded; white balance can be measured accurately even when the camera is not in focus.



6 Check the results.

If the camera was able to measure a value for white balance, the message shown at right will be displayed and **Wd** will flash in the viewfinder and the camera will return to shooting mode. To return to shooting mode immediately, press the shutter-release button halfway.

If lighting is too dark or too bright, the camera may be unable to measure white balance. A message will appear in the information display and a flashing **no Wd** will appear in the viewfinder. Return to Step 5 and measure white balance again.

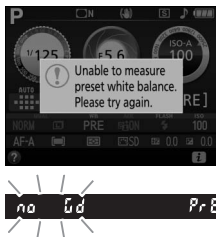
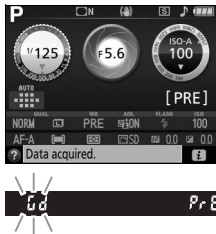

✔ Measuring Preset White Balance

If no operations are performed while the displays are flashing, direct measurement mode will end in the time selected for the **Auto off timers** option in the setup menu (☞ 207).

✔ Preset White Balance

The camera can store only one value for preset white balance at a time; the existing value will be replaced when a new value is measured.

Note that exposure is automatically increased by 1 EV when measuring white balance; when shooting in mode **M**, adjust exposure so that the exposure indicator shows ± 0 (☞ 106).

✔ Other Methods for Measuring Preset White Balance

To enter preset measurement mode (see above) after selecting preset white balance in the information display (☞ 122), press **OK** for a few seconds. If white balance has been assigned to the **Fn** button (☞ 214), white balance preset measurement mode can be activated by keeping the **Fn** button pressed for a few seconds after selecting preset white balance with the **Fn** button and command dial.

✔ Gray Panels

For more precise results, measure white balance using a standard gray panel.

■ Copying White Balance from a Photograph

Follow the steps below to copy a value for white balance from a photograph on the memory card.

1 Select Preset manual.

Highlight **White balance** in the shooting menu and press \odot to display white balance options. Highlight **Preset manual** and press \odot .

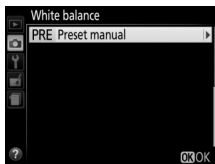

2 Select Use photo.

Highlight **Use photo** and press \odot .

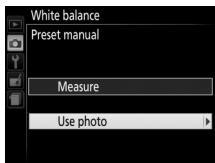

3 Choose Select image.

Highlight **Select image** and press \odot (to skip the remaining steps and use the image last selected for preset white balance, select **This image**).



4 Choose a folder.

Highlight the folder containing the source image and press \odot .

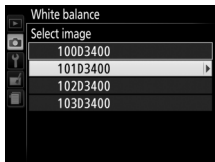

5 Highlight the source image.

To view the highlighted image full frame, press and hold the  button.



6 Copy white balance.







Press  to set preset white balance to the white balance value for the highlighted photograph.

Picture Controls

Picture Controls are preset combinations of image processing settings that include sharpening, clarity, contrast, brightness, saturation, and hue. You can select a Picture Control to match the scene or customize settings to suit your creative intent.

Selecting a Picture Control

Choose a Picture Control according to the subject or type of scene.

Option	Description
 SD Standard	Recommended for most situations, this option uses standard processing for balanced results.
 NL Neutral	A good choice for photographs that will later be processed or retouched, this option uses minimal processing for natural results.
 VI Vivid	Choose this option for photographs that emphasize primary colors. Pictures are enhanced for a vivid, photoprint effect.
 MC Monochrome	Take monochrome photographs.
 PT Portrait	Process portraits for skin with natural texture and a rounded feel.
 LS Landscape	Produces vibrant landscapes and cityscapes.
 FL Flat	Choose for photographs that will later be extensively processed or retouched. Details are preserved over a wide tone range, from highlights to shadows.

-
- 1 Display Picture Control options.**
Press the **i** button, then highlight the current Picture Control and press **OK**.

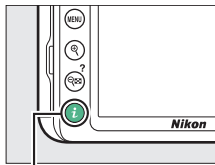

i button



-
- 2 Select a Picture Control.**
Highlight a Picture Control and press **OK**.



Modifying Picture Controls

Picture Controls can be modified to suit the scene or the user's creative intent. Choose a balanced combination of settings using **Quick adjust**, or make manual adjustments to individual settings.

1 Select a Picture Control.

Highlight **Set Picture Control** in the shooting menu and press **OK**.

Highlight the desired Picture Control and press **OK**.

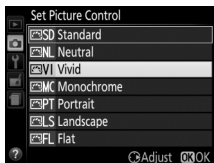

2 Adjust settings.

Press **Left** or **Right** to highlight the desired setting and press **Left** or **Right** to choose a value in increments of 1, or rotate the command dial to choose a value in increments of 0.25 (see page 135). Repeat this step until all settings have been adjusted, or select a preset combination of settings by using the multi selector to choose **Quick adjust**. Default settings can be restored by pressing the **Reset** button.



3 Save changes and exit.

Press **OK**.

Picture Controls that have been modified from default settings are indicated by an asterisk ("*").

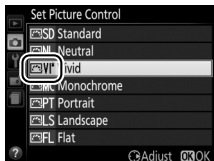

Picture Control Settings

Option	Description	
Quick adjust	Mute or heighten the effect of the selected Picture Control (note that this resets all manual adjustments). Not available with Neutral , Monochrome , or Flat Picture Controls.	
Manual adjustments (all Picture Controls)	Sharpening	Control the sharpness of outlines. Select A to adjust sharpening automatically according to the type of scene.
	Clarity	Adjust clarity manually or select A to let the camera adjust clarity automatically. Depending on the scene, shadows may appear around bright objects or halos may appear around dark objects at some settings. Clarity is not applied to movies.
	Contrast	Adjust contrast manually or select A to let the camera adjust contrast automatically.
	Brightness	Raise or lower brightness without loss of detail in highlights or shadows.
Manual adjustments (non-monochrome only)	Saturation	Control the vividness of colors. Select A to adjust saturation automatically according to the type of scene.
	Hue	Adjust hue.
Manual adjustments (monochrome only)	Filter effects	Simulate the effect of color filters on monochrome photographs (☐ 137).
	Toning	Choose the tint used in monochrome photographs (☐ 137).

✔ "A" (Auto)

Results for auto sharpening, clarity, contrast, and saturation vary with exposure and the position and size of the subject relative to the frame.

✔ Switching Between Manual and Auto

Press the  button to switch back and forth between manual and auto (A) settings for sharpening, clarity, contrast, and saturation.



✔ Previous Settings

The  indicator under the value display in the Picture Control setting menu indicates the previous value for the setting. Use this as a reference when adjusting settings.



Filter Effects (Monochrome Only)

The options in this menu simulate the effect of color filters on monochrome photographs. The following filter effects are available:

Option		Description
Y	Yellow	Enhances contrast. Can be used to tone down the brightness of the sky in landscape photographs. Orange produces more contrast than yellow, red more contrast than orange.
O	Orange	
R	Red	
G	Green	Softens skin tones. Can be used for portraits.

Toning (Monochrome Only)

Pressing \odot when **Toning** is selected displays saturation options. Press \odot or \odot to adjust saturation in increments of 1, or rotate the command dial to choose a value in increments of 0.25. Saturation control is not available when **B&W** (black-and-white) is selected.



Recording and Viewing Movies

Recording Movies

Movies can be recorded in live view mode.

1 Press the **Lv** button.

The view through the lens will be displayed in the monitor.

✓ The Icon

A  icon (📖 10) indicates that movies can not be recorded.

✓ Before Recording

Set aperture before recording in mode **A** or **M** (📖 103, 105).

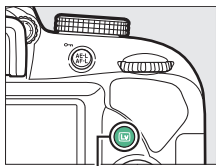

Lv button

2 Focus.

Frame the opening shot and focus. Note that the number of subjects that can be detected in face-priority AF drops during movie recording.



3 Start recording.

Press the movie-record button to start recording. A recording indicator and the time available are displayed in the monitor. Sound is recorded via the built-in microphone (📖 2); be careful not to obstruct the microphone during recording. Except in **AUTO** and **☺** modes, exposure can be locked by pressing the **AE-L/AF-L** (🔒) button (📖 113) or (in scene, **P**, **S**, **A**, and **📷** modes) altered by up to ± 3 EV in steps of $\frac{1}{3}$ EV by pressing the **Ⓜ** (Ⓜ) button and rotating the command dial (📖 116; note that depending on the brightness of the subject, changes to exposure may have no visible effect).

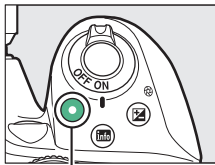

Movie-record button

Recording indicator



Time remaining

4 End recording.

Press the movie-record button again to end recording. Recording will end automatically when the maximum length is reached, the memory card is full, or another mode is selected.

5 End live view.

Press the **LV** button to end live view.

📌 Taking Photographs During Movie Recording

To end movie recording, take a photograph, and exit to live view, press the shutter-release button all the way down and hold it in this position until the shutter is released.

Maximum Length

The maximum length for individual movie files is 4 GB (for maximum recording times, see page 141); note that depending on memory card write speed, shooting may end before this length is reached (□ 269).

Recording Movies

Flicker, banding, or distortion may be visible in the monitor and in the final movie under fluorescent, mercury vapor, or sodium lamps or with subjects that are in motion, particularly if the camera is panned horizontally or an object moves horizontally at high speed through frame (for information on reducing flicker and banding, see **Flicker reduction**; □ 213). Jagged edges, color fringing, moire, and bright spots may also appear. Bright regions or bands may appear in some areas of the frame with flashing signs and other intermittent light sources or if the subject is briefly illuminated by a strobe or other bright, momentary light source. Avoid pointing the camera at the sun or other strong light sources. Failure to observe this precaution could result in damage to the camera's internal circuitry.

The camera can record both video and sound; do not cover the microphone during recording. Note that the built-in microphone may record lens noise during autofocus and vibration reduction.



Flash lighting can not be used during movie recording.

Matrix metering is used regardless of the metering method selected. Shutter speed and ISO sensitivity are adjusted automatically unless **On** is selected for **Manual movie settings** (□ 142) and the camera is in mode **M**.

Movie Settings

The camera offers the following movie options.

- **Frame size/frame rate and Movie quality:** The maximum length varies with the options selected.

Movie quality	Frame size/frame rate ¹	Maximum length ²
High quality	 1920×1080; 60p	10 min.
	 1920×1080; 50p	
	 1920×1080; 30p	20 min.
	 1920×1080; 25p	
	 1920×1080; 24p	
	 1280× 720; 60p	
	 1280× 720; 50p	
Normal	 1920×1080; 60p	20 min.
	 1920×1080; 50p	29 min. 59 s
	 1920×1080; 30p	
	 1920×1080; 25p	
	 1920×1080; 24p	
	 1280× 720; 60p	
	 1280× 720; 50p	

¹ Listed value. Actual frame rates for 60p, 50p, 30p, 25p, and 24p are 59.94, 50, 29.97, 25, and 23.976 fps respectively.

² Movies recorded in miniature effect mode are up to three minutes long when played back.

- **Microphone:** Turn the built-in microphone on or off or adjust microphone sensitivity. Choose **Auto sensitivity** to adjust sensitivity automatically, **Microphone off** to turn sound recording off; to select microphone sensitivity manually, select **Manual sensitivity** and choose a sensitivity.

- **Wind noise reduction:** Select **On** to enable the low-cut filter for the built-in microphone, reducing noise produced by wind blowing over the microphone (note that other sounds may also be affected).
- **Manual movie settings:** Choose **On** to allow manual adjustments to shutter speed and ISO sensitivity when the camera is in mode **M**. Shutter speed can be set to values as fast as $\frac{1}{4000}$ s; the slowest speed available varies with the frame rate: $\frac{1}{30}$ s for frame rates of 24p, 25p, and 30p, $\frac{1}{50}$ s for 50p, and $\frac{1}{60}$ s for 60p. If shutter speed is not in this range when live view starts, it will automatically be set to a supported value, and remain at this value when live view ends. Note that ISO sensitivity is fixed at the value selected; the camera does not adjust ISO sensitivity automatically when **On** is selected for **ISO sensitivity settings** > **Auto ISO sensitivity control** in the shooting menu (📖 193).

1 Select Movie settings.

Press the **MENU** button to display the menus. Highlight **Movie settings** in the shooting menu and press **▶**.



2 Choose movie options.

Highlight the desired item and press **▶**, then highlight an option and press **OK**.

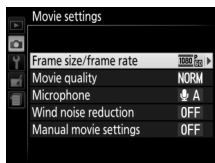

HDMI

When the camera is attached to an HDMI video device, the video device will display the view through the lens. If the device supports HDMI-CEC, select **Off** for the **HDMI** > **Device control** option in the setup menu (📖 185) before shooting in live view.

The Live View Display

The movie crop can be viewed during live view by pressing the **info** button to select the “show movie indicators,” “hide indicators,” or “framing grid” display (□ 8). When movie indicators are displayed, you can access the following movie settings by pressing the **i** button: movie frame size/quality, white balance (□ 121), microphone sensitivity (□ 141), exposure compensation (□ 115), focus mode (□ 70), AF-area mode (□ 75), wind noise reduction (□ 142), and Picture Control (□ 132). If **On** is selected for **Movie settings > Manual movie settings** (□ 142) in mode **M**, ISO sensitivity (□ 93) can be adjusted in place of exposure compensation.

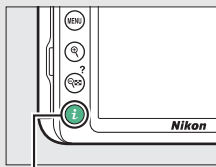

i button



Selecting **1920×1080; 60p** or **1920×1080; 50p** for **Frame size/frame rate** (□ 141) reduces the size of the movie crop. The cropped view is shown in the monitor.





*Information display
(1920×1080; 60p/
1920×1080; 50p)*







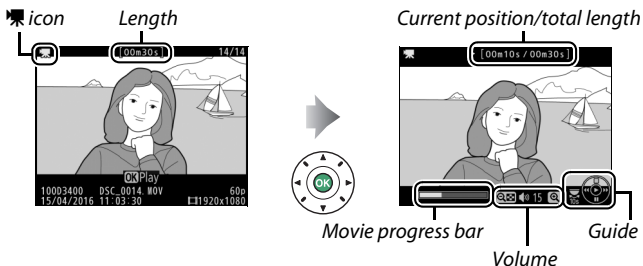

During recording







Viewing Movies

Movies are indicated by a  icon in full-frame playback ( 152). Press  to start playback; your current position is indicated by the movie progress bar.





The following operations can be performed:

To	Use	Description
Pause		Pause playback.
Play		Resume playback when movie is paused or during rewind/advance.
Advance/rewind		Speed increases with each press, from 2x to 4x to 8x to 16x; keep pressed to skip to beginning or end of movie (first frame is indicated by  in top right corner of monitor, last frame by ). If playback is paused, movie rewinds or advances one frame at a time; hold for continuous rewind or advance.
Start slow-motion playback		Press  while the movie is paused to start slow-motion playback.

To	Use	Description
Skip 10 s		Rotate the command dial to skip ahead or back 10 s.
Adjust volume		Press  to increase volume,  (?) to decrease.
Return to full-frame playback		Press  or  to exit to full-frame playback.

Editing Movies

Trim footage to create edited copies of movies or save selected frames as JPEG stills.

Option	Description
 Choose start/end point	Create a copy from which unwanted footage has been removed.
 Save selected frame	Save a selected frame as a JPEG still.





Trimming Movies



To create trimmed copies of movies:

1 Display a movie full frame.

2 Pause the movie on the new opening frame.

Play the movie back as described on page 144, pressing  to start and resume playback and  to pause and pressing  or  or rotating the command dial to locate the desired frame. Your approximate position in the movie can be ascertained from the movie progress bar. Pause playback when you reach the new opening frame.



Movie progress bar

3 Select **Choose start/end point**.

Press the **i** button, then highlight **Choose start/end point** and press .

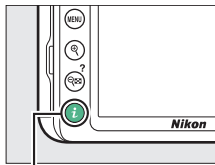

i button

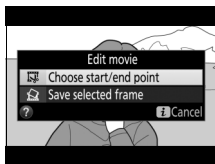

4 Select **Start point**.

To create a copy that begins from the current frame, highlight **Start point** and press . The frames before the current frame will be removed when you save the copy in Step 9.

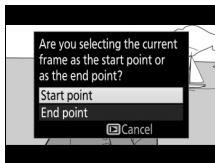

Start point

5 Confirm the new start point.

If the desired frame is not currently displayed, press ⏪ or ⏩ to advance or rewind (to skip to 10 s ahead or back, rotate the command dial).



6 Choose the end point.

Press AE-L / AF-L (⏪) to switch from the start point (⏪) to the end point (⏩) selection tool and then select the closing frame as described in Step 5. The frames after the selected frame will be removed when you save the copy in Step 9.

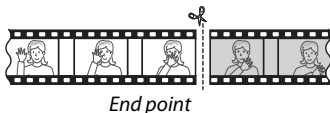

7 Create the copy.

Once the desired frame is displayed, press ⏩.

8 Preview the movie.

To preview the copy, highlight **Preview** and press ⏹ (to interrupt the preview and return to the save options menu, press ⏩). To abandon the current copy and select a new start point or end point as described on the foregoing pages, highlight **Cancel** and press ⏹; to save the copy, proceed to Step 9.

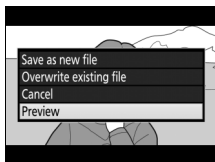

9 Save the copy.

Highlight **Save as new file** and press **OK** to save the copy to a new file. To replace the original movie file with the edited copy, highlight **Overwrite existing file**, highlight **Overwrite existing file** and press **OK**.

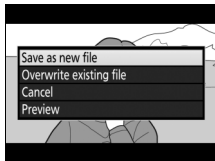

✓ Trimming Movies

Movies must be at least two seconds long. The copy will not be saved if there is insufficient space available on the memory card.

Copies have the same time and date of creation as the original.

✍ Removing Opening or Closing Footage

To remove only the opening footage from the movie, proceed to Step 7 without pressing the **AE-1** (**⏪**) button in Step 6. To remove only the closing footage, select **End point** in Step 4, select the closing frame, and proceed to Step 7 without pressing the **AE-1** (**⏪**) button in Step 6.

Saving Selected Frames

To save a copy of a selected frame as a JPEG still:

1 Pause the movie on the desired frame.

Play the movie back as described on page 144, pressing **OK** to start and resume playback and **STOP** to pause. Pause the movie at the frame you intend to copy.



2 Choose **Save selected frame**.

Press the **i** button, then highlight **Save selected frame** and press **OK**.

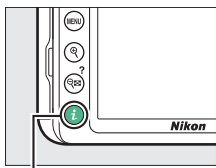

i button

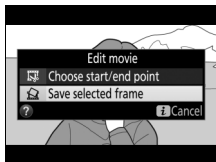



3 Create a still copy.

Press  to create a still copy of the current frame.



4 Save the copy.

Highlight **Yes** and press  to create a fine-quality ( 84) JPEG copy of the selected frame.

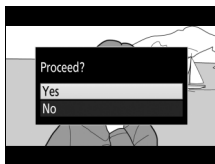

Save Selected Frame

JPEG movie stills created with the **Save selected frame** option can not be retouched. JPEG movie stills lack some categories of photo information ( 156).







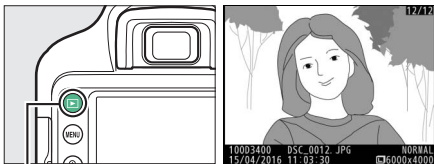





Playback and Deletion

Full-Frame Playback

To play photographs back, press the  button. The most recent photograph will be displayed in the monitor.







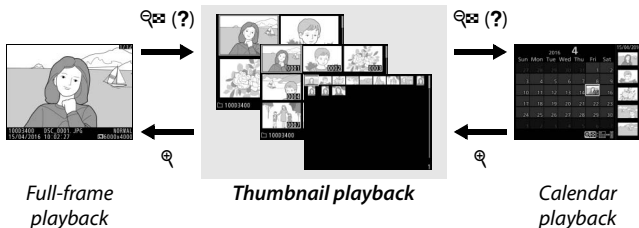

 button

To	Use	Description
View additional photographs		Press  to view photographs in order recorded,  to view photographs in reverse order.
View additional photo info		Change photo info displayed ( 156).
Return to shooting mode	 / 	Press the  button or press the shutter-release button halfway to exit to shooting mode.
Play movie		If current picture is marked with  icon to show that it is a movie, pressing  starts movie playback ( 144).

Thumbnail Playback

To display images in “contact sheets” of 4, 9, or 72 images, press the  (?) button.



To	Use	Description
Highlight images		Use multi selector or command dial to highlight pictures.
View highlighted image		Press  to display the highlighted image full frame.
Return to shooting mode	 / 	Press the  button or press the shutter-release button halfway to exit to shooting mode.

Calendar Playback

To view images taken on a selected date, press the (?) button when 72 images are displayed.

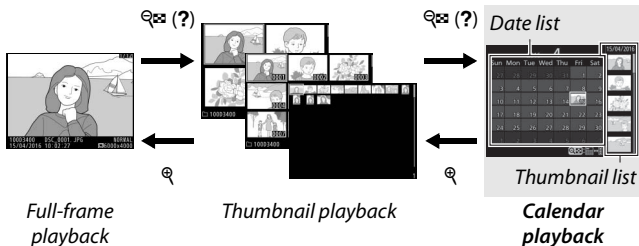

The operations that can be performed depend on whether the cursor is in the date list or the thumbnail list:

To	Use	Description
Toggle between date list and thumbnail list		Press (?) or button in date list to place cursor in thumbnail list. Press (?) again to return to date list.
Exit to thumbnail playback/Zoom in on highlighted photo		<ul style="list-style-type: none"> • Date list: Exit to 72-frame playback. • Thumbnail list: Press and hold button to zoom in on highlighted picture.
Highlight dates/Highlight images		<ul style="list-style-type: none"> • Date list: Highlight date. • Thumbnail list: Highlight picture.
Toggle full frame playback		Thumbnail list: View highlighted picture.
Return to shooting mode	/	Press the button or press the shutter-release button halfway to exit to shooting mode.

The *i* Button

Pressing the *i* button in full-frame, thumbnail, or calendar playback displays the options listed below. Highlight items and press \odot to view options.

- **Rating:** Rate the current picture (📖 169).
- **Retouch (photographs only):** Use the options in the retouch menu (📖 227) to create a retouched copy of the current photograph.
- **Edit movie (movies only):** Edit movies using the options in the edit movie menu (📖 146). Movies can also be edited by pressing the *i* button when movie playback is paused.
- **Select to send to smart device/deselect (photographs only):** Select photos for upload to a smart device.

To exit the *i*-button menu and return to playback, press the *i* button again.

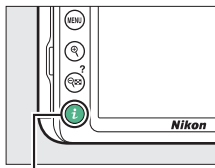

i button

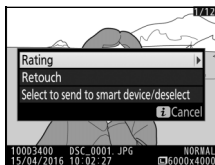
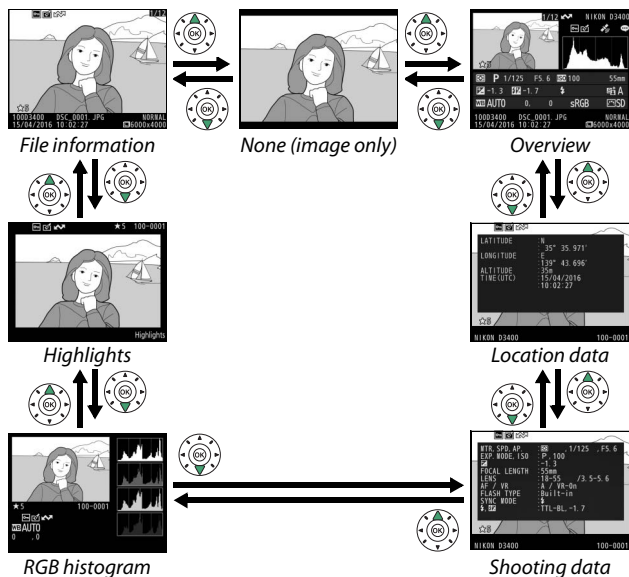
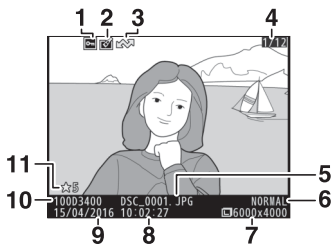

Photo Information

Photo information is superimposed on images displayed in full-frame playback. Press or to cycle through photo information as shown below. Note that “image only”, shooting data, RGB histograms, highlights, and overview data are only displayed if corresponding option is selected for **Playback display options** (187). Location data are only displayed if embedded in the picture (221).



■ ■ File Information



1	Protect status	168	6	Image quality	84
2	Retouch indicator	228	7	Image size.....	86
3	Upload marking	155, 189	8	Time of recording	25, 205
4	Frame number/total number of images		9	Date of recording.....	25, 205
5	File name	221	10	Folder name	219
			11	Rating	169

■ ■ Highlights*



1	Image highlights	2	Folder number-frame number
---	------------------	---	----------------------------

* Flashing areas indicate highlights (areas that may be overexposed).

■ ■ RGB Histogram

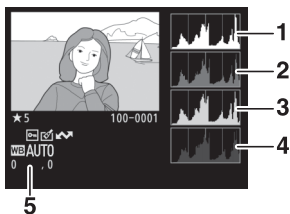

1 Histogram (RGB channel). In all histograms, horizontal axis gives pixel brightness, vertical axis number of pixels.

2 Histogram (red channel)

3 Histogram (green channel)

4 Histogram (blue channel)

5 White balance..... 121
White balance fine-tuning 124
Preset manual..... 126

✔ Playback Zoom

To zoom in on the photograph when the histogram is displayed, press \mathcal{Q} . Use the \mathcal{Q} and \mathcal{Q} (?) buttons to zoom in and out and scroll the image with the multi selector. The histogram will be updated to show only the data for the portion of the image visible in the monitor.



Histograms

Camera histograms are intended as a guide only and may differ from those displayed in imaging applications. Some sample histograms are shown below:

If the image contains objects with a wide range of brightnesses, the distribution of tones will be relatively even.



If the image is dark, tone distribution will be shifted to the left.



If the image is bright, tone distribution will be shifted to the right.



Increasing exposure compensation shifts the distribution of tones to the right, while decreasing exposure compensation shifts the distribution to the left. Histograms can provide a rough idea of overall exposure when bright ambient lighting makes it difficult to see photographs in the monitor.

■ Shooting Data

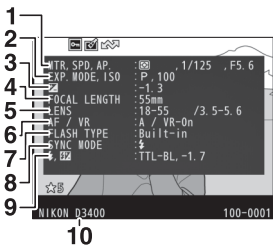

<p>1 Metering 111</p> <p>Shutter speed 98</p> <p>Aperture 98</p> <p>2 Shooting mode 32, 48, 51, 98</p> <p>ISO sensitivity¹ 93</p> <p>3 Exposure compensation 115</p> <p>4 Focal length 261</p> <p>5 Lens data</p> <p>6 Focus mode 69</p> <p>Lens VR (vibration reduction)²</p> <p>..... 17, 198</p>	<p>7 Flash type 197, 262</p> <p>Commander mode²</p> <p>8 Flash mode 88, 90</p> <p>9 Flash control 197</p> <p>Flash compensation 117</p> <p>10 Camera name</p>
---	--

- 1 Displayed in red if photo was taken with auto ISO sensitivity control on.
- 2 Displayed only in photos taken with accessories that support this function.



11	White balance	121	12	Color space	194
	White balance fine-tuning	124	13	Picture Control*	132
	Preset manual.....	126			

* Items displayed vary with Picture Control selected.

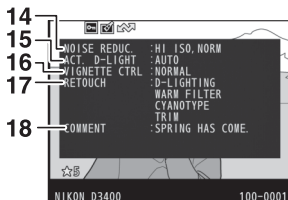

14	Noise reduction.....	195	17	Retouch history.....	227
15	Active D-Lighting*	119	18	Image comment	211
16	Vignette control	195			

* **AUTO** is displayed if photo was taken with Active D-Lighting on.



19 Name of photographer* 212 **20** Copyright holder* 212

* Copyright information is only displayed if recorded with the **Copyright information** option in the setup menu.

Overview Data

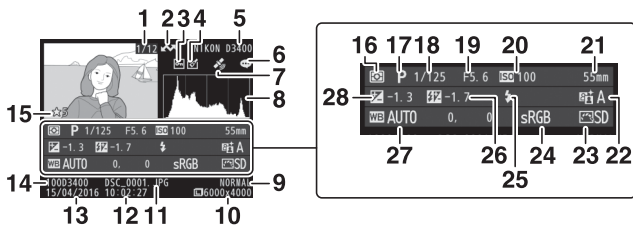

1	Frame number/total number of images	15	Rating	169	
2	Upload marking	155, 189	16	Metering	111
3	Protect status	168	17	Shooting mode	32, 48, 51, 98
4	Retouch indicator	228	18	Shutter speed	98
5	Camera name		19	Aperture	98
6	Image comment indicator	211	20	ISO sensitivity ¹	93
7	Location data indicator	221	21	Focal length	261
8	Histogram showing the distribution of tones in the image (159).		22	Active D-Lighting ²	119
9	Image quality	84	23	Picture Control	132
10	Image size	86	24	Color space	194
11	File name	221	25	Flash mode	88, 90
12	Time of recording	25, 205	26	Flash compensation	117
13	Date of recording	25, 205		Commander mode ³	
14	Folder name	219	27	White balance	121
				White balance fine-tuning	124
				Preset manual	126
			28	Exposure compensation	115

1 Displayed in red if photo was taken with ISO sensitivity auto control on.

2 **AUTO** is displayed if photo was taken with Active D-Lighting on.















3 Displayed only in photos taken with accessories that support this function.



■ ■ *Location Data*

The latitude, longitude, and other location data are supplied by and vary with the smart device (📖 221). In the case of movies, the data give the location at the start of recording.

Taking a Closer Look: Playback Zoom

Press the  button to zoom in on the image displayed in full-frame playback or on the image currently highlighted in thumbnail or calendar playback. The following operations can be performed while zoom is in effect:

To	Use	Description
Zoom in or out	 /  (?)	Press  to zoom in to maximum of approximately 38× (large images), 28× (medium images) or 19× (small images). Press  (?) to zoom out. While photo is zoomed in, use multi selector to view areas of image not visible in monitor. Keep multi selector pressed to scroll rapidly to other areas of frame. Navigation window is briefly displayed when zoom ratio is altered; area currently visible in monitor is indicated by yellow border. Zoom ratio is shown by bar at bottom of navigation window; when zoom ratio is 100%, bar is displayed green.
View other areas of image		
Crop image		To crop image to area currently visible in monitor, press  and select Trim ( 166).
Zoom in on faces		To zoom in on faces detected by camera, press  and select Face zoom ( 167). This option is available only if faces are detected. If faces are detected when the RGB histogram ( 158) display is zoomed in, Face zoom will be available in the  -button menu (Trim , however, will not be available).

To	Use	Description
View other images		Rotate command dial to view same location in other images at current zoom ratio. Playback zoom is cancelled when a movie is displayed.
Cancel zoom		Cancel zoom and return to full-frame playback.
Change protect status	AE-L AF-L 	See page 168 for more information.

■ Cropping Photos

Follow the steps below to crop photos displayed during playback zoom to the area currently visible in the monitor.

1 Press **i**.

After adjusting zoom and scrolling the photo until only the area you wish to keep is visible in the monitor, press the **i** button.

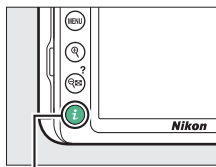

i button

2 Select **Trim**.

Highlight **Trim** and press .



3 Select **Done**.

Highlight **Done** and press  to create a cropped copy containing only the portion of the image displayed in the monitor.



■ ■ Face Zoom

To zoom in on a face detected by the camera, press the **i** button in the zoom display and then highlight **Face zoom** and press **OK**.

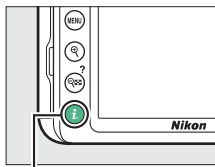



i button

The current subject is indicated by a white frame in the navigation window. Press **Q** or **Q** (?) to zoom in or out, or use the multi selector to view other faces.



Protecting Photographs from Deletion

Press the AE-L/AF-L (O-n) button to protect the current picture from accidental deletion. Protected files are marked with a  icon and can not be deleted using the  button or the **Delete** option in the playback menu. Note that protected images will be deleted when the memory card is formatted (📖 201). To remove protection from a picture so that it can be deleted, display or highlight it and press the AE-L/AF-L (O-n) button.

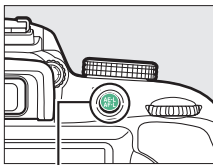

AE-L/AF-L (O-n) button



Removing Protection from All Images

To remove protection from all images in the folder or folders currently selected in the **Playback folder** menu (📖 187), press the AE-L/AF-L (O-n) and  buttons together for about two seconds during playback.

Rating Pictures

Rate pictures or mark them as candidates for later deletion. Ratings can also be viewed in ViewNX-i and Capture NX-D. Rating is not available with protected images.

Rating Individual Pictures

- 1 Select an image.**
Display or highlight the image.

- 2 Display playback options.**
Press the **i** button to display playback options.

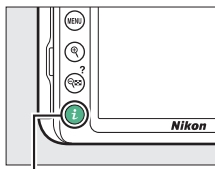

i button

- 3 Select Rating.**
Highlight **Rating** and press **▶**.

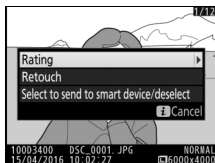

- 4 Choose a rating.**
Press **◀** or **▶** to choose a rating of from zero to five stars, or select **✖** to mark the picture as a candidate for later deletion. Press **OK** to complete the operation.



Rating Multiple Pictures





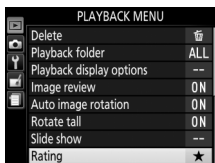

Use the **Rating** option in the playback menu to rate multiple pictures.

1 Select Rating.

Highlight **Rating** in the playback menu and press .



2 Rate pictures.

Use the multi selector to highlight pictures (to view the currently highlighted picture full frame, press and hold the  button) and keeping the  (?) button pressed, press  or  to choose a rating of from zero to five stars, or select  to mark the picture as a candidate for later deletion. Press  to complete the operation.

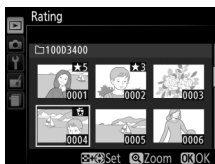

Deleting Photographs

To delete the current photograph, press the  button. To delete multiple selected photographs, all photographs taken on a selected date, or all photographs in the current playback folder, use the **Delete** option in the playback menu. Once deleted, photographs can not be recovered. Note that pictures that are protected can not be deleted.

During Playback

Press the  button to delete the current photograph.

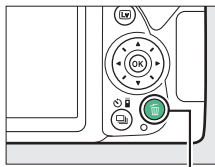

1 Press the button.

A confirmation dialog will be displayed.



 button

2 Press the button again.

To delete the photograph, press the  button again. To exit without deleting the photograph, press the  button.

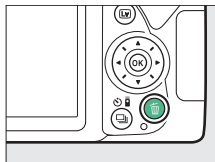



Calendar Playback

During calendar playback, you can delete all photographs taken on a selected date by highlighting the date in the date list and pressing the  button ([154](#)).



The Playback Menu

The **Delete** option in the playback menu contains the following options. Note that depending on the number of images, some time may be required for deletion.

Option	Description
 Selected	Delete selected pictures.
 Select date	Delete all pictures taken on a selected date (□ 173).
ALL All	Delete all pictures in the folder currently selected for playback (□ 187).

■ Selected: Deleting Selected Photographs

- 1 Select the highlighted picture.**

Use the multi selector to highlight a picture and press the  (?) button to select or deselect (to view the highlighted picture full screen, press and hold the  button). Selected pictures are marked by a  icon. Repeat as desired to select additional pictures.

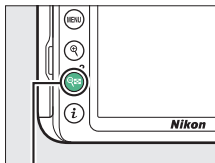

 (?) button

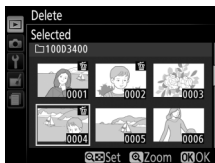



- 2 Press  to complete the operation.**

A confirmation dialog will be displayed; highlight **Yes** and press .



■ Select Date: Deleting Photographs Taken on a Selected Date

1 Select dates.

Highlight a date and press  to select all pictures taken on the highlighted date. Selected dates are indicated by check marks. Repeat as desired to select additional dates; to deselect a date, highlight it and press .

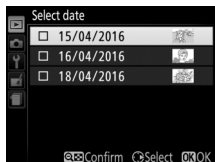

2 Press to complete the operation.

A confirmation dialog will be displayed; highlight **Yes** and press .



Slide Shows

The **Slide show** option in the playback menu is used to display a slide show of the pictures in the current playback folder (📖 187).

1 Select Slide show.

Highlight **Slide show** in the playback menu and press .

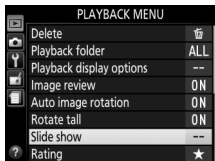





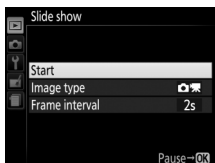



2 Start the slide show.

Highlight **Start** in the slide show menu and press .



The following operations can be performed while the slide show is in progress:

To	Use	Description
Skip back/skip ahead		Press  to return to previous frame,  to skip to next frame.
View additional photo info		Change photo info displayed (📖 156).
Pause		Pause show. Select Restart to resume.
Raise/lower volume		Press  during movie playback to increase volume,  (?) to decrease.
Exit to playback mode		End show and return to playback mode.

The dialog shown at right is displayed when the show ends. Select **Restart** to restart or **Exit** to return to the playback menu.



Slide Show Options

Before starting a slide show, you can use the options in the slide show menu to select the images displayed by type or rating and choose how long each image is displayed.

- **Image type:** Choose from **Still images and movies**, **Still images only**, **Movies only**, and **By rating**. To include only pictures with selected ratings, highlight **By rating** and press . A list of ratings will be displayed; highlight ratings and press to select or deselect pictures with the highlighted rating for inclusion in the slide show. Selected ratings are indicated by a check mark. Press to exit when the desired ratings are selected.
- **Frame interval:** Choose how long still images are displayed.

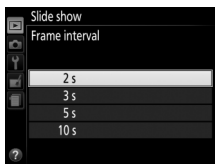

Connections

Installing ViewNX-i

To fine-tune photos and upload and view pictures, download the latest version of the ViewNX-i installer from the following website and follow the on-screen instructions to complete installation. An Internet connection is required. For system requirements and other information, see the Nikon website for your region.

<http://downloadcenter.nikonimglib.com/>

Capture NX-D

Use Nikon's Capture NX-D software to fine-tune photos or to change settings for NEF (RAW) pictures and save them in other formats.

Capture NX-D is available for download from:

<http://downloadcenter.nikonimglib.com/>

Copying Pictures to the Computer

Before proceeding, be sure you have installed ViewNX-i (☐ 177).

1 Connect the USB cable.

After turning the camera off and ensuring that a memory card is inserted, connect a USB cable (available separately) as shown and then turn the camera on.

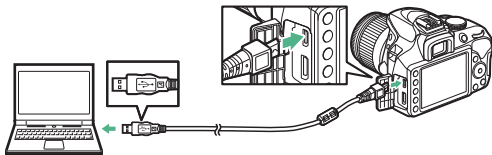

✔ USB Hubs

Connect the camera directly to the computer; do not connect the cable via a USB hub or keyboard.

✔ Use a Reliable Power Source

To ensure that data transfer is not interrupted, be sure the camera battery is fully charged.

✔ Connecting Cables

Be sure the camera is off when connecting or disconnecting interface cables. Do not use force or attempt to insert the connectors at an angle.

2 Start Nikon Transfer 2 component of ViewNX-i.

If a message is displayed prompting you to choose a program, select Nikon Transfer 2.

✔ **During Transfer**

Do not turn the camera off or disconnect the USB cable while transfer is in progress.

✍ **Windows 7**

If the following dialog is displayed, select Nikon Transfer 2 as described below.

- 1 Under **Import pictures and videos**, click **Change program**. A program selection dialog will be displayed; select Nikon Transfer 2 and click **OK**.



- 2 Double-click .

✍ **Windows 10 and Windows 8.1**

Windows 10 and Windows 8.1 may display an AutoPlay prompt when the camera is connected. Tap or click the dialog and then tap or click **Nikon Transfer 2** to select Nikon Transfer 2.

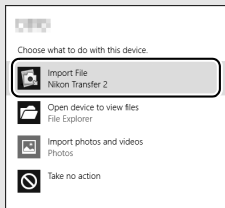
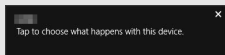

✍ **OS X**

If Nikon Transfer 2 does not start automatically, confirm that the camera is connected and then launch Image Capture (an application that comes with OS X) and select Nikon Transfer 2 as the application that opens when the camera is detected.

3 Click **Start Transfer**.

Pictures on the memory card will be copied to the computer.



Start Transfer

4 Terminate the connection.

When transfer is complete, turn the camera off and disconnect the USB cable.

For More Information

Consult online help for more information on using ViewNX-i.

Printing Photographs

Selected JPEG images can be printed on a PictBridge printer (☞ 303) connected directly to the camera.

Connecting the Printer

Connect the camera using a USB cable (available separately). Do not use force or attempt to insert the connectors at an angle.

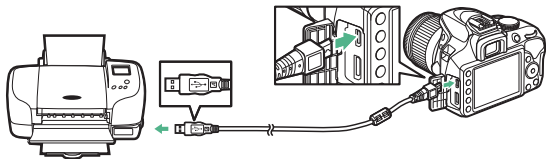

When the camera and printer are turned on, a welcome screen will be displayed in the monitor, followed by a PictBridge playback display.

✔ Selecting Photographs for Printing

NEF (RAW) photographs (☞ 84) can not be selected for printing. JPEG copies of NEF (RAW) images can be created using the **NEF (RAW) processing** option in the retouch menu (☞ 230).

✔ Date Imprint

If you select **On** for **Print date** in the PictBridge menu when printing photographs containing date information recorded using **Date stamp** in the setup menu (☞ 202), the date will appear twice. The imprinted date may however be cropped out if the photographs are cropped or printed without a border.

Printing Pictures One at a Time

1 Display the desired picture.

Press or to view additional pictures. Press the button to zoom in on the current frame (165; press to exit zoom). To view six pictures at a time, press the (?) button. Use the multi selector to highlight pictures, or press to display the highlighted picture full frame.

2 Adjust printer settings.

Press to display the following items, then press or to highlight an item and press to view options (only options supported by the current printer are listed; to use the default option, select **Printer default**). After selecting an option, press to return to the printer settings menu.

Option	Description
Page size	Choose a page size.
No. of copies	This option is listed only when pictures are printed one at a time. Press or to choose number of copies (maximum 99).
Border	Choose whether to frame photos in white borders.
Print date	Choose whether to print the times and dates of recordings on photos.
Cropping	This option is listed only when pictures are printed one at a time. To exit without cropping, highlight No cropping and press . To crop the current picture, highlight Crop and press . A crop selection dialog will be displayed; press to increase the size of the crop, (?) to decrease, and use the multi selector to position the crop. Note that print quality may drop if small crops are printed at large sizes.

3 Start printing.

Select **Start printing** and press to start printing. To cancel before all copies have been printed, press .











Printing Multiple Pictures

1 Display the PictBridge menu.

Press the MENU button in the PictBridge playback display.

2 Choose an option.



Highlight one of the following options and press .

- **Print select:** Select pictures for printing. Use the multi selector to highlight pictures (to view the highlighted picture full screen, press and hold the ) and keeping the  (?) button pressed, press  or  to choose the number of prints. To deselect a picture, set the number of prints to zero.
 - **Select date:** Print one copy of all the pictures taken on selected dates. Press  or  to highlight dates and press  to select or deselect. To view the pictures taken on the selected date, press  (?). Use the multi selector to scroll through the pictures, or press and hold  to view the current picture full screen. Press  (?) again to return to the date selection dialog.
 - **Index print:** To create an index print of all JPEG pictures on the memory card, proceed to Step 3. Note that if the memory card contains more than 256 pictures, only the first 256 images will be printed. A warning will be displayed if the page size selected in Step 3 is too small for an index print.
-

3 Adjust printer settings.

Adjust printer settings as described in Step 2 on page 182.

4 Start printing.

Select **Start printing** and press  to start printing. To cancel before all copies have been printed, press .

Viewing Pictures on TV

The optional **High-Definition Multimedia Interface (HDMI)** cable (📖 268) can be used to connect the camera to high-definition video devices. Always turn the camera off before connecting or disconnecting an HDMI cable.

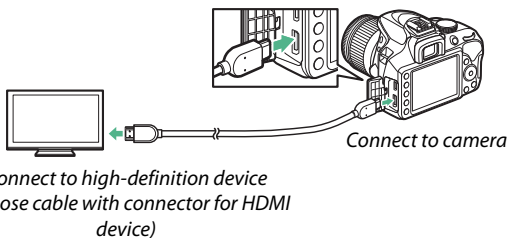

Tune the device to the HDMI channel, then turn the camera on and press the  button. During playback, images will be displayed on the television screen. Note that the edges of images may not be displayed.

Playback Volume

Volume can be adjusted using television controls; the camera controls can not be used.

Television Playback

Use of an AC adapter (available separately) is recommended for extended playback.

■ ■ Choosing an Output Resolution

To choose the format for images output to the HDMI device, select **HDMI** >

Output resolution in the camera setup menu (📖 199). If **Auto** is selected, the camera will automatically select the appropriate format.

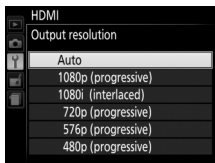

■ ■ Controlling the Camera with the TV Remote

If **On** is selected for **HDMI** > **Device control** in the setup menu (📖 199) when the camera is connected to a television that supports HDMI-CEC and both the camera and television are on, the television remote can be used in place of the camera multi selector and \odot button during full-frame playback and slide shows. If **Off** is selected, the television remote can not be used to control the camera, but the camera can be used to shoot photographs and movies in live view.

✔ HDMI-CEC Devices

HDMI-CEC (High-Definition Multimedia Interface–Consumer Electronics Control) is a standard that allows HDMI devices to be used to control peripherals to which they are connected. When the camera is connected to an HDMI-CEC device, \square \square \square will appear in the viewfinder in place of the number of exposures remaining.

✔ 1920 × 1080 60p/50p

Selecting **1920 × 1080; 60p** or **1920 × 1080; 50p** for **Movie settings** > **Frame size/frame rate** may cause variations in the resolution and frame rate of the data output to HDMI devices during recording.

✔ HDMI > Output Resolution

Movies can not be output at resolutions of **1920 × 1080; 60p** or **1920 × 1080; 50p**. Some devices may not support an **Output resolution** setting of **Auto**.

Camera Menu

▶ The Playback Menu: *Managing Images*

To display the playback menu, press **MENU** and select the ▶ (playback menu) tab.

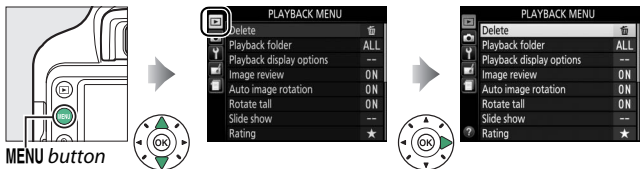

Playback Menu Options

The playback menu contains the following options:

Option	Default	
Delete	—	172
Playback folder	All	187
Playback display options	—	187
Image review	On	188
Auto image rotation	On	188
Rotate tall	On	189
Slide show		
Image type	Still images and movies	174
Frame interval	2 s	
Rating	—	170
Select to send to smart device	—	189

Playback Folder





MENU button →  playback menu

Choose a folder for playback:

Option	Description
D3400	Pictures in all folders created with the D3400 will be visible during playback.
All	Pictures in all folders will be visible during playback.
Current	Only photos in the folder currently selected for Storage folder in the setup menu ( 219) are displayed during playback.

Playback Display Options

MENU button →  playback menu

Choose the information available in the playback photo information display ( 156). Press  or  to highlight and press  to select or deselect. Selected items are indicated by check marks. To return to the playback menu, press .

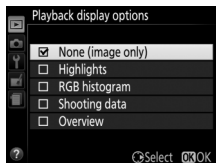



Image Review

MENU button →  playback menu

Choose whether pictures are automatically displayed in the monitor immediately after shooting. If **Off** is selected, pictures can only be displayed by pressing the  button.

Auto Image Rotation

MENU button →  playback menu

Photographs taken while **On** is selected contain information on camera orientation, allowing them to be rotated automatically during playback or when viewed in ViewNX-i or in Capture NX-D. The following orientations are recorded:



*Landscape (wide)
orientation*



*Camera rotated 90°
clockwise*



*Camera rotated 90°
counterclockwise*

Camera orientation is not recorded when **Off** is selected. Choose this option when panning or taking photographs with the lens pointing up or down.

Rotate Tall

MENU button →  playback menu

If **On** is selected, “tall” (portrait-orientation) pictures will be automatically rotated for display in the monitor (pictures taken with **Off** selected for **Auto image rotation** will still be displayed in landscape orientation). Note that because the camera itself is already in the appropriate orientation during shooting, images are not rotated automatically during image review.

Select to Send to Smart Device

MENU button →  playback menu

Select photos for upload to the smart device. Movies can not be selected for upload.

Option	Description
Select image(s)	Mark pictures for upload to the smart device.
Deselect all	Remove the upload markings from all pictures.

The Shooting Menu: *Shooting Options*



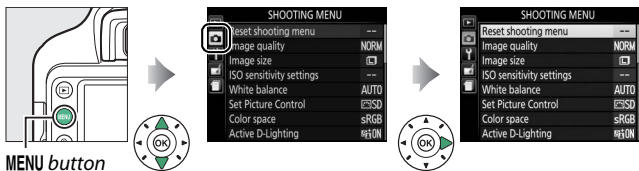







To display the shooting menu, press **MENU** and select the  (shooting menu) tab.



Shooting Menu Options

The shooting menu contains the following options:

Option	Default	
Reset shooting menu	—	192
Image quality	JPEG normal	84
Image size	Large	86
ISO sensitivity settings		
ISO sensitivity	P, S, A, M	100
	Other modes	Auto
Auto ISO sensitivity control	On	
Maximum sensitivity	25600	193
Minimum shutter speed	Auto	
White balance	Auto	121
Fluorescent	Cool-white fluorescent	123
Set Picture Control	Standard	132
Color space	sRGB	194
Active D-Lighting	On	119
Noise reduction	On	195
Vignette control	Normal	195

Option	Default		
Auto distortion control	Off	196	
Focus mode			
Viewfinder	Auto-servo AF	69	
Live view/movie	Single-servo AF	70	
AF-area mode			
Viewfinder	 ,  ,  , 	Single-point AF	74
		Dynamic-area AF	
	Other modes	Auto-area AF	
Live view/ movie	 ,  ,  , 	Face-priority AF	75
		Normal-area AF	
	Other modes	Wide-area AF	
Built-in AF-assist illuminator	On	196	
Metering	Matrix metering	111	
Flash cntrl for built-in flash/ Optional flash	TTL	197	
Optical VR*	On	198	
Movie settings			
Frame size/frame rate	1920×1080; 60p	141, 142	
Movie quality	Normal		
Microphone	Auto sensitivity		
Wind noise reduction	Off		
Manual movie settings	Off		

* Available only with lenses that support this item.

Note: Depending on camera settings, some items may be grayed out and unavailable.







Reset Shooting Menu

MENU button →  shooting menu

Select **Yes** to reset shooting menu settings.

Reset Shooting Options

Selecting **Yes** for **Reset shooting menu** also restores Picture Control settings to their default values (📖 134) and resets the following:

Option	Default	📖
Release mode		
	Continuous	62
Other modes	Single frame	
Focus point	Center	76
Flexible program	Off	100
AE-L/AF-L  button hold	Off	215
Flash mode		
 ,  , VI, POP,  TOY	Auto	87, 89
	Auto slow sync	
	Flash off	
P, S, A, M	Fill flash	
Exposure compensation	Off	115
Flash compensation	Off	117

ISO Sensitivity Settings

MENU button →  shooting menu

Adjust ISO sensitivity (📖 93).

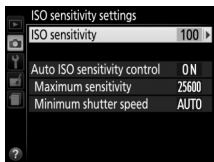

■ Auto ISO Sensitivity control

This option is available with type E and G lenses (📖 253) when the camera is in **P**, **S**, **A**, or **M** mode. If **Off** is selected, ISO sensitivity will remain fixed at the value selected by the user (📖 93). When **On** is chosen, ISO sensitivity will automatically be adjusted if optimal exposure can not be achieved at the value selected by the user. The maximum value for auto ISO sensitivity can be selected using the **Maximum sensitivity** option in the **Auto ISO sensitivity control** menu (choose lower values to prevent noise (randomly-spaced bright pixels, fog, or lines), but note that if the ISO sensitivity selected by the user is higher than that chosen for **Maximum sensitivity**, the value selected by the user will be used instead; the minimum value for auto ISO sensitivity is automatically set to ISO 100). In modes **P** and **A**, sensitivity will only be adjusted if underexposure would result at the shutter speed selected for **Minimum shutter speed** ($1/2000$ –30 s, or **Auto**; in modes **S** and **M**, sensitivity will be adjusted for optimal exposure at the shutter speed selected by the user). If **Auto** is selected, the camera will choose the minimum shutter speed based on the focal length of the lens. Slower shutter speeds will be used only if optimal exposure can not be achieved at the ISO sensitivity value selected for **Maximum sensitivity**.

When **On** is selected, the viewfinder shows **ISO AUTO** and the information display **ISO-A**. These indicators flash when sensitivity is altered from the value selected by the user.



Maximum Sensitivity/Minimum Shutter Speed

When auto ISO sensitivity control is enabled, the ISO sensitivity and shutter speed graphics in the information display show the maximum sensitivity and minimum shutter speed.



Auto ISO Sensitivity Control

Note that ISO sensitivity may be raised automatically when auto ISO sensitivity control is used in combination with slow sync flash modes (available with the built-in flash and the optional flash units listed on page 262), possibly preventing the camera from selecting slow shutter speeds. Auto ISO sensitivity control is available only in i-TTL flash control mode (☐ 197, 262); in other modes, the value selected for **ISO sensitivity** will be used for pictures taken with the built-in flash or optional flash units.

Color Space

MENU button → shooting menu

The color space determines the gamut of colors available for color reproduction. **sRGB** is recommended for general-purpose printing and display; **Adobe RGB**, with its broader gamut of colors, for professional publication and commercial printing. Regardless of the option selected, movies are recorded in sRGB.

Adobe RGB

For accurate color reproduction, Adobe RGB images require applications, displays, and printers that support color management.

Color Space

ViewNX-i and Capture NX-D automatically select the correct color space when opening photographs created with this camera. Results can not be guaranteed with third-party software.

Noise Reduction

MENU button →  shooting menu

Select **On** to reduce noise (bright spots, randomly-spaced bright pixels, or fog).



Noise reduction takes effect at all ISO

sensitivities, but is most noticeable at higher values. The time required for processing at shutter speeds slower than about 1 s roughly doubles; during processing, “nob nr” will flash in the viewfinder and photographs can not be taken. Noise reduction will not be performed if the camera is turned off before processing is complete.

If **Off** is selected, noise reduction will only be performed as required; the amount of noise reduction is less than that performed when **On** is selected.

Vignette Control

MENU button →  shooting menu

“Vignetting” is a drop in brightness at the edges of a photograph. **Vignette control** reduces vignetting for type E and G lenses (📖 253). Its effects vary from lens to lens and are most noticeable at maximum aperture. Choose from **High**, **Normal**, **Low**, and **Off**.

Vignette Control

Depending on the scene, shooting conditions, and type of lens, JPEG images may exhibit noise (fog) or variations in peripheral brightness, while preset Picture Controls that have been modified from default settings may not produce the desired effect. Take test shots and view the results in the monitor. Vignette control does not apply to movies (📖 138) or to pictures taken with lenses that support FX format.

Auto Distortion Control

MENU button →  shooting menu

Select **On** to reduce barrel distortion when shooting with wide-angle lenses and to reduce pin-cushion distortion when shooting with long lenses (note that the edges of the area visible in the viewfinder may be cropped out of the final photograph, and that the time needed to process photographs before recording begins may increase). This option does not apply to movies and is available only with type E and G lenses (fisheye, and certain other lenses excluded); results are not guaranteed with other lenses.

Retouch: Distortion Control

For information on creating copies of existing photographs with reduced barrel and pin-cushion distortion, see page 237.

Built-in AF-assist Illuminator

MENU button →  shooting menu

Choose whether the built-in AF-assist illuminator lights to assist the focus operation when lighting is poor.

AF-assist illuminator

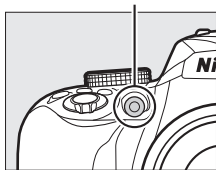



Option	Description
On	The AF-assist illuminator lights when lighting is poor (for more information, see page 284).
Off	The AF-assist illuminator does not light to assist the focus operation. The camera may not be able to focus using autofocus when lighting is poor.



Flash Cntrl for Built-in Flash/Optional Flash

MENU button →  shooting menu

Choose the flash mode for the built-in flash in **P**, **S**, **A**, and **M** modes. When an optional SB-500, SB-400, or SB-300 flash unit is attached and turned on, this option changes to **Optional flash** and is used to choose the flash mode for the optional flash unit.

Option	Description
 TTL	Flash output is adjusted automatically in response to shooting conditions.
 Manual	Choose a flash level. At full power, the built-in flash has a Guide Number of approximately 8/26 (m/ft., ISO 100, 20 °C/68 °F).

Manual

A  icon flashes in the viewfinder and  appears in the information display when **Manual** is selected and the flash is raised.



TTL Flash Control

The following types of flash control are supported when a type E or G lens is used in combination with the built-in flash (□ 87) or optional flash units (□ 262).

- **i-TTL Balanced Fill-Flash for Digital SLR:** Information from the 420-pixel RGB sensor is used to adjust flash output for a natural balance between the main subject and the background.
- **Standard i-TTL Fill-Flash for Digital SLR:** Flash output is adjusted for the main subject; the brightness of the background is not taken into account.

Standard i-TTL flash control is used with spot metering or when selected with the optional flash unit. i-TTL balanced fill-flash for digital SLR is used in all other cases.

Optical VR

MENU button →  shooting menu

This item is displayed only with lenses that support it. Selecting **On** enables vibration reduction, which takes effect whenever the shutter-release button is pressed halfway (□ 309, 314, 318). Select **Off** to disable vibration reduction.

The Vibration Reduction Indicator

A vibration reduction indicator appears in the information display when **On** is selected for **Optical VR**.



Y The Setup Menu: Camera Setup

To display the setup menu, press **MENU** and select the **Y** (setup menu) tab.

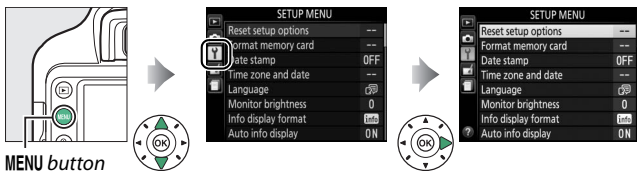

MENU button

Setup Menu Options

The setup menu contains the following options:

Option	Default	
Reset setup options	—	201
Format memory card	—	201
Date stamp	Off	202
Time zone and date ¹		
Sync with smart device	Off	205
Daylight saving time	Off	205
Language ¹	—	205
Monitor brightness	0	205
Info display format		
AUTO/SCENE/EFFECTS	Graphic	206
P/S/A/M	Graphic	
Auto info display	On	206
Auto off timers	Normal	207
Self-timer		
Self-timer delay	10 s	208
Number of shots	1	

Option	Default	📖
Remote on duration (ML-L3)	1 min	208
Lock mirror up for cleaning ²	—	273
Image Dust Off ref photo	—	209
Image comment	—	211
Copyright information	—	212
Beep	Low	213
Flicker reduction	Auto	213
Buttons		
Assign Fn button	ISO sensitivity	214
Assign AE-L/AF-L button	AE/AF lock	215
Shutter-release button AE-L	Off	215
AF activation	Enable	215
Rangefinder	Off	216
Manual focus ring in AF mode ³	Enable	217
File number sequence	Off	218
Storage folder	—	219
File naming	DSC	221
HDMI		
Output resolution	Auto	185
Device control	On	
Location data		
Download from smart device	No	221
Position	—	
Airplane mode	Disable	222
Connect to smart device	—	222
Send to smart device (auto)	Off	223
Bluetooth		
Network connection	Disable	223
Paired devices	—	
Send while off	On	

Option	Default	
Eye-Fi upload ⁴	Enable	224
Conformity marking	—	225
Slot empty release lock	Release locked	226
Reset all settings	—	226
Firmware version	—	226

1 Default varies with country of purchase.

2 Not available when battery is low.

3 Available only with lenses that support this item.

4 Only available when compatible Eye-Fi memory card is inserted ( 224).

Note: Depending on camera settings, some items may be grayed out and unavailable.

Reset Setup Options

MENU button →  setup menu

Select **Yes** to reset all setup menu settings except **Time zone and date**, **Language**, **Storage folder**, and **Bluetooth > Paired devices** to the defaults listed above.

Format Memory Card

MENU button →  setup menu

Memory cards must be formatted before first use or after being formatted in other devices. Format the card as described below.

Formatting Memory Cards

Formatting memory cards permanently deletes any data they may contain. Be sure to copy any photographs and other data you wish to keep to a computer before proceeding ( 178).

1 Highlight Yes.

To exit without formatting the memory card, highlight **No** and press .



2 Press .



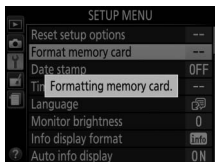

A message will be displayed while the card is formatted. *Do not remove the memory card or remove or disconnect the power source until formatting is complete.*



Date Stamp

MENU button →  setup menu

Choose the date information imprinted on photographs as they are taken. Date stamps can not be added to or removed from existing photos.

Option	Description
Off	The time and date do not appear on photographs.
DATE Date	The date or date and time are imprinted on photographs taken while this option is in effect. 
DATE  Date and time	
 Date counter	New photos are imprinted with a time stamp showing the number of days between the date of shooting and a selected date (📅 203).

At settings other than **Off**, the selected option is indicated by a **DATE** icon in the information display.



Date Stamp

The date is recorded in the order selected for **Time zone and date** (☞ 205). The imprinted data may be cropped out or rendered illegible in copies created when images are retouched (☞ 227). The date does not appear on NEF (RAW) or NEF (RAW)+JPEG images.

Date Counter

Pictures taken while this option is in effect are imprinted with the number of days remaining until a future date or the number of days elapsed since a past date. Use it to track the growth of a child or count down the days until a birthday or wedding.

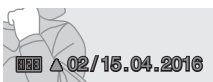
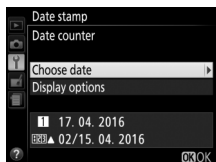

*Future date
(two days remaining)*

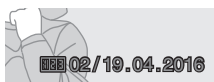

*Past date
(two days elapsed)*

The camera offers three slots for storing dates.

1 Enter the first date.

The first time you select **Date counter**, you will be prompted to enter a date for the first slot. Enter a date using the multi selector and press **OK** to exit to the date list.

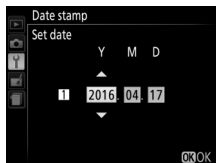

2 Enter additional dates or edit existing dates.

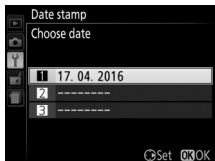

To change a date or enter additional dates, highlight a slot, press , and enter a date as described above.



3 Choose a date.

Highlight a slot in the date list and press .

4 Choose a date counter format.

Highlight **Display options** and press , then highlight a date format and press .

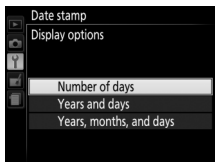

5 Exit the date counter menu.

Press  to exit the date counter menu.

Time Zone and Date

MENU button →  setup menu

Change time zones, synchronize the clock with the clock on a smart device, set the camera clock, choose the date display order, and turn daylight saving time on or off.

Option	Description
Time zone	Choose a time zone. The camera clock is automatically set to the time in the new time zone.
Date and time	Set the camera clock (□□ 25).
Sync with smart device	Choose whether the camera clock is updated to the time (Coordinated Universal Time, or UTC), time zone, and standard or daylight saving time supplied by the smart device.
Date format	Choose the order in which the day, month, and year are displayed.
Daylight saving time	Turn daylight saving time on or off. The camera clock will automatically be advanced or set back one hour.



Language

MENU button →  setup menu

Choose a language for camera menus and messages.

Monitor Brightness

MENU button →  setup menu

Press  or  to choose monitor brightness. Choose higher values for increased brightness, lower values for reduced brightness.

Info Display Format

MENU button →  setup menu

Choose an information display format (📖 6). Formats can be chosen separately for auto, scene, and special effects modes and for **P**, **S**, **A**, and **M** modes.



Classic



Graphic

- 1 Select a shooting mode option.
Highlight **AUTO/SCENE/EFFECTS** or **P/S/A/M** and press .

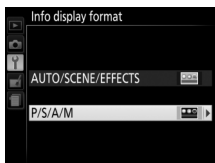

- 2 Select a design.
Highlight a design and press .



Auto Info Display



MENU button →  setup menu

If **On** is selected, the information display will appear after the shutter-release button is pressed halfway. If **Off** is selected, the information display can be viewed by pressing the  button.

Auto off Timers

MENU button →  setup menu

This option determines how long the monitor remains on if no operations are performed during menu display and playback (**Playback/menus**), while photographs are displayed in the monitor after shooting (**Image review**), and during live view (**Live view**), and how long the standby timer, viewfinder, and information display remain on when no operations are performed (**Standby timer**). Choose shorter auto-off delays to reduce the drain on the battery.

Option	Description (all times are approximate)				
SHORT Short NORM Normal LONG Long	Auto off timers are set to the following values:				
		Playback/ menus	Image review	Live view	Standby timer
	Short	20 s	4 s	5 min.	4 s
	Normal	5 min.	4 s	10 min.	8 s
Long	10 min.	20 s	20 min.	1 min.	
  Custom	Choose separate delays for Playback/menus , Image review , Live view , and Standby timer . When settings are complete, press  .				



Auto off Timers

The monitor and viewfinder will not turn off automatically when the camera is connected to a computer or printer via USB.

Self-Timer

MENU button →  setup menu

Choose the length of the shutter release delay and the number of shots taken.

- **Self-timer delay:** Choose the length of the shutter-release delay.
- **Number of shots:** Press  and  to choose the number of shots taken each time the shutter-release button is pressed (from 1 to 9; if a value other than 1 is selected, shots will be taken at intervals of about 4 seconds).

Remote on Duration (ML-L3)

MENU button →  setup menu

Choose how long the camera will wait for a signal from the optional ML-L3 remote control before cancelling remote release mode. Choose shorter times for longer battery life. This setting applies only during viewfinder photography.

Image Dust Off Ref Photo

MENU button → Y setup menu

Acquire reference data for the Image Dust Off option in Capture NX-D (for more information, refer to Capture NX-D online help).

Image Dust Off ref photo is available only when a type E or G lens is mounted on the camera. A lens with a focal length of at least 50 mm is recommended. When using a zoom lens, zoom all the way in.

1 Select Start.

Highlight **Start** and press **OK**. To exit without acquiring image dust off data, press **MENU**.



The message shown at right will be displayed and "rEF" will appear in the viewfinder.



2 Frame a featureless white object in the viewfinder.

With the lens about ten centimeters (four inches) from a well-lit, featureless white object, frame the object so that it fills the viewfinder and then press the shutter-release button halfway.

In autofocus mode, focus will automatically be set to infinity; in manual focus mode, set focus to infinity manually.

3 Acquire Image Dust Off reference data.

Press the shutter-release button the rest of the way down to acquire Image Dust Off reference data. The monitor turns off when the shutter-release button is pressed.

If the reference object is too bright or too dark, the camera may be unable to acquire Image Dust Off reference data and the message shown at right will be displayed. Choose another reference object and repeat the process from Step 1.





Image Dust Off Reference Data

The same reference data can be used for photographs taken with different lenses or at different apertures. Reference images can not be viewed using computer imaging software. A grid pattern is displayed when reference images are viewed on the camera.





Image Comment

MENU button →  setup menu



Add a comment to new photographs as they are taken. Comments can be viewed as metadata in ViewNX-i or Capture NX-D. The comment is also visible on the shooting data page in the photo information display ( 161). The following options are available:

- **Input comment:** Input a comment as described below. Comments can be up to 36 characters long.

- **Attach comment:** Select this option to attach the comment to all subsequent photographs. **Attach comment** can be turned on and off by highlighting it and pressing . After choosing the desired setting, press  to exit.



Text Entry



The dialog at right is displayed when text entry is required. Use the multi selector to highlight the desired character in the keyboard area and press  to insert the highlighted character at the current cursor position (note that if a character is entered when the field is full, the last character in the field will be deleted). To delete the character under the cursor, press the  button. To move the cursor to a new position, rotate the command dial. To complete entry and return to the previous menu, press . To exit without completing text entry, press MENU.

Text display area



Keyboard area

Add copyright information to new photographs as they are taken. Copyright information is included in the shooting data shown in the photo information display and can be viewed as metadata in ViewNX-i or in Capture NX-D. The following options are available:

- **Artist:** Enter a photographer name as described on page 211. Photographer names can be up to 36 characters long.
- **Copyright:** Enter the name of the copyright holder as described on page 211. Copyright holder names can be up to 54 characters long.
- **Attach copyright information:** Select this option to attach copyright information to all subsequent photographs. **Attach copyright information** can be turned on and off by highlighting it and pressing . After choosing the desired setting, press  to exit.





Copyright Information

To prevent unauthorized use of the artist or copyright holder names, make sure that **Attach copyright information** is not selected and that the **Artist** and **Copyright** fields are blank before lending or transferring the camera to another person. Nikon does not accept liability for any damages or disputes arising from the use of the **Copyright information** option.

Beep

MENU button →  setup menu



Choose the pitch (**High** or **Low**) of the beep that sounds when the camera focuses and in self-timer and remote-control modes. Select **Off** to prevent the beep from sounding.

The current setting is shown in the information display:  is displayed when the beep is on,  when it is off.



Flicker Reduction

MENU button →  setup menu

Reduce flicker and banding when shooting under fluorescent or mercury-vapor lighting during live view ( 39) or movie recording ( 138). Choose **Auto** to allow the camera to automatically choose the correct frequency, or manually match the frequency to that of the local AC power supply.

Flicker Reduction

If **Auto** fails to produce the desired results and you are unsure as to the frequency of the local power supply, test both 50 and 60 Hz options and choose the one that produces the best results. Flicker reduction may not produce the desired results if the subject is very bright, in which case you should select mode **A** or **M** and choose a smaller aperture (higher f-number) before starting live view. Note that flicker reduction is not available when **On** is selected for **Movie settings** > **Manual movie settings** ( 142) in mode **M**.

■ Assign Fn Button

Choose the role played by the **Fn** button.

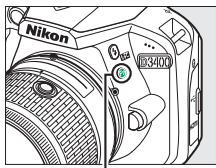

Fn button



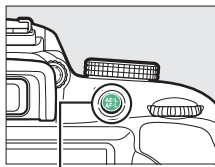

	Option	Description
QUAL	Image quality/size	Keeping the Fn button pressed, rotate the command dial to select image quality and size (□ 84).
ISO	ISO sensitivity	Keeping the Fn button pressed, rotate the command dial to select ISO sensitivity (□ 93).
WB	White balance	Keeping the Fn button pressed, rotate the command dial to select white balance (P , S , A , and M modes only; □ 121).
	Active D-Lighting	Keeping the Fn button pressed, rotate the command dial to select Active D-Lighting (P , S , A , and M modes only; □ 119).

Assign AE-L/AF-L Button

Choose the role played by the AE-L/AF-L (On) button.



AE-L/AF-L (On) button

Option	Description
 AE/AF lock	Focus and exposure lock while the AE-L/AF-L (On) button is pressed.
 AE lock only	Exposure locks while the AE-L/AF-L (On) button is pressed.
 AE lock (Hold)	Exposure locks when the AE-L/AF-L (On) button is pressed, and remains locked until the button is pressed a second time or the standby timer expires.
 AF lock only	Focus locks while the AE-L/AF-L (On) button is pressed.
 AF-ON	The AE-L/AF-L (On) button initiates autofocus.

Shutter-Release Button AE-L

If **On** is selected, exposure will lock when the shutter-release button is pressed halfway.







AF Activation

Choose whether the camera focuses when the shutter-release button is pressed halfway.

Rangefinder

MENU button →  setup menu

Choose **On** to use the exposure indicator to determine whether the camera is correctly focused in manual focus mode (☐ 81; note that this function is not available in shooting mode **M**, when the exposure indicator instead shows whether the subject is correctly exposed).

Indicator	Description
	Subject in focus.
	Focus point is slightly in front of subject.
	Focus point is well in front of subject.
	Focus point is slightly behind subject.
	Focus point is well behind subject.
	Camera can not determine correct focus.

Using the Electronic Rangefinder

The electronic rangefinder requires a lens with a maximum aperture of $f/5.6$ or faster. The desired results may not be achieved in situations in which the camera would be unable to focus using autofocus (☐ 72). The electronic rangefinder is not available during live view.

Manual Focus Ring in AF Mode

MENU button →  setup menu

This item is displayed only with lenses that support it. Selecting **Enable** allows the lens focus ring to be used for manual focus when the camera is in autofocus mode; this is known as “autofocus with manual override” (M/A). After pressing the shutter-release button halfway to focus, keep the button pressed halfway and adjust focus using the focus ring. To refocus using autofocus, lift your finger from the shutter-release button and then press it halfway again. To prevent the lens focus ring being used for manual focus when the camera is in autofocus mode, select **Disable**.

File Number Sequence

MENU button →  setup menu

When a photograph is taken, the camera names the file by adding one to the last file number used. This option controls whether file numbering continues from the last number used when a new folder is created, the memory card is formatted, or a new memory card is inserted in the camera.

Option	Description
On	When a new folder is created, the memory card formatted, or a new memory card inserted in the camera, file numbering continues from the last number used or from the largest file number in the current folder, whichever is higher. If a photograph is taken when the current folder contains a photograph numbered 9999, a new folder will be created automatically and file numbering will begin again from 0001.
Off	File numbering is reset to 0001 when a new folder is created, the memory card formatted, or a new memory card inserted in the camera. Note that a new folder is created automatically if a photograph is taken when the current folder contains 999 photographs.
Reset	As for On , except that the next photograph taken is assigned a file number by adding one to the largest file number in the current folder. If the folder is empty, file numbering is reset to 0001.

File Number Sequence

If the current folder is numbered 999 and contains either 999 photographs or a photograph numbered 9999, the shutter-release button will be disabled and no further photographs can be taken. Choose **Reset** for **File number sequence** and then either format the current memory card or insert a new memory card.







Select the folder in which subsequent images will be stored.



■ ■ *Selecting Folders by Folder Number*

1 Choose **Select folder by number**.

Highlight **Select folder by number** and press .

2 Choose a folder number.

Press  or  to highlight a digit, press  or  to change. If a folder with the selected number already exists, a , , or  icon will be displayed to the left of the folder number:

-  : Folder is empty.
 -  : Folder is partially full.
 -  : Folder contains 999 pictures or a picture numbered 9999. No further pictures can be stored in this folder.
-

3 Save changes and exit.

Press  to complete the operation and return to the main menu (to exit without choosing the storage folder, press the MENU button). If a folder with the specified number does not already exist, a new folder will be created. Subsequent photographs will be stored in the selected folder unless it is already full.



■ Selecting Folders from a List

1 Choose **Select folder from list**.

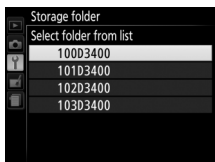
Highlight **Select folder from list** and press .



2 Highlight a folder.

Press  or  to highlight a folder.

3 Select the highlighted folder.

Press  to select the highlighted folder and return to the main menu. Subsequent photographs will be stored in the selected folder.

Folder and File Numbers

If the current folder is numbered 999 and contains 999 pictures or a picture numbered 9999, the shutter-release will be disabled and no further photographs can be taken. To continue shooting, create a folder with a number less than 999, or select an existing folder with a number less than 999 and less than 999 images.

Startup Time

Additional time may be required for camera startup if the memory card contains a very large number of files or folders.

File Naming

MENU button →  setup menu

Photographs are saved using file names consisting of “DSC_” or, in the case of images that use the Adobe RGB color space (📖 194), “_DSC”, followed by a four-digit number and a three-letter extension (e.g., “DSC_0001.JPG”). The **File naming** option is used to select three letters to replace the “DSC” portion of the file name. For information on editing file names, see page 211.

Extensions

The following extensions are used: “.NEF” for NEF (RAW) images, “.JPG” for JPEG images, “.MOV” for movies, and “.NDF” for dust off reference data. In each pair of photographs recorded at image-quality settings of NEF (RAW)+JPEG, the NEF and JPEG images have the same file names but different extensions.

Location Data

MENU button →  setup menu

Adjust location data settings for use when the camera is connected to a smart device.

Option	Description
Download from smart device	Select Yes to download location data from the smart device and embed them in pictures taken over the next two hours. Location data can not be acquired if the camera is off or the standby timer has expired.
Position	View the location data supplied by a smart device (the items displayed vary with the device). The data for movies are those reported at the start of recording.

Airplane Mode

MENU button →  setup menu

Select **Enable** to disable the wireless features of Eye-Fi cards and Bluetooth connections to smart devices.

Connect to Smart Device

MENU button →  setup menu

Adjust settings for connection to smart devices.



Security

Although one of the benefits of this product is that it allows others to freely connect for the wireless exchange of data anywhere within its range, the following may occur if security is not enabled:

- **Data theft:** Malicious third-parties may intercept wireless transmissions to steal user IDs, passwords, and other personal information.
- **Unauthorized access:** Unauthorized users may gain access to the network and alter data or perform other malicious actions. Note that due to the design of wireless networks, specialized attacks may allow unauthorized access even when security is enabled.

Send to Smart Device (Auto)

MENU button →  setup menu

If **On** is selected, new photos will automatically be uploaded to the smart device (if the camera is not currently connected to the smart device, the photos will be marked for upload and uploaded the next time a wireless connection is established). Movies are not uploaded.

Upload Marking

No more than 1000 photos can be marked for upload at a time.

Before changing the rating of photos that are marked for upload, select **Disable** for **Bluetooth** > **Network connection** or switch wireless off by selecting **Enable** for **Airplane mode**.

Bluetooth



MENU button →  setup menu

List paired devices and adjust settings for connection to smart devices.

Option	Description
Network connection	Enable or disable Bluetooth.
Paired devices	View paired devices.
Send while off	Select Off to suspend wireless transmissions when the camera is turned off or the standby timer expires.



Eye-Fi Upload

MENU button →  setup menu

This option is displayed only when an Eye-Fi memory card (available separately from third-party suppliers) is inserted in the camera. Choose **Enable** to upload photographs to a preselected destination. Note that pictures will not be uploaded if signal strength is insufficient. Before uploading pictures via Eye-Fi, select **Disable** for **Airplane mode** ( 222) and **Bluetooth > Network connection** (.

Observe all local laws concerning wireless devices and choose **Disable** where wireless devices are prohibited.

Eye-Fi Cards

Eye-Fi cards may emit wireless signals when **Disable** is selected. A  icon displayed when **Disable** is selected indicates that the camera is unable to control the Eye-Fi card ( 291); turn the camera off and remove the card.







Select longer values for **Auto off timers > Standby timer** in the setup menu when using an Eye-Fi card.

See the manual provided with the Eye-Fi card, and direct any inquiries to the manufacturer. The camera can be used to turn Eye-Fi cards on and off, but may not support other Eye-Fi functions.

Airplane Mode (222)

Enabling airplane mode disables Eye-Fi upload. To resume Eye-Fi upload, select **Disable** for **Airplane mode** before selecting **Enable** for **Eye-Fi upload**.

When an Eye-Fi card is inserted, its status is indicated by an icon in the information display:

- : Eye-Fi upload disabled.
- : Eye-Fi upload enabled but no pictures available for upload.
-  (static): Eye-Fi upload enabled; waiting to begin upload.
-  (animated): Eye-Fi upload enabled; uploading data.
- : Error — camera can not control Eye-Fi card. If a flashing  appears in the viewfinder, check that the Eye-Fi card firmware is up-to-date; if the error persists after the card firmware has been updated, insert a different card or format the card in the camera after copying any pictures it contains to a computer or other storage device. If the  indicator is not flashing, pictures can be taken normally but you may be unable to change Eye-Fi settings.



Supported Eye-Fi Cards

Some cards may not be available in some countries or regions; consult the manufacturer for more information. Eye-Fi cards are for use only in the country of purchase. Be sure the Eye-Fi card firmware has been updated to the latest version.

Conformity Marking

MENU button →  setup menu

View a selection of the standards with which the camera complies.

Slot Empty Release Lock

MENU button →  setup menu

If **Release locked** is selected, the shutter-release button is only enabled when a memory card is inserted in the camera. Selecting **Enable release** allows the shutter to be released when no memory card is inserted, although no pictures will be recorded (they will however be displayed in the monitor in demo mode).

Reset All Settings

MENU button →  setup menu

Reset all settings except **Language, Time zone and date**, and **GUIDE** mode options to their default values (☞ 190, 192, 201). Copyright information, image comments, and other user-generated entries are also reset. Observe caution when using this option: once settings are reset, the original values can only be restored through separate manual adjustments to each of the affected items.

Firmware Version

MENU button →  setup menu

View the current camera firmware version.





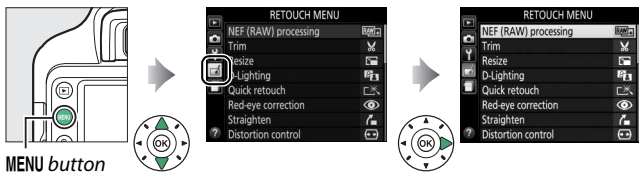















The Retouch Menu: Creating Retouched Copies

To display the retouch menu, press **MENU** and select the  (retouch menu) tab.



Retouch Menu Options

The options in the retouch menu are used to create trimmed or retouched copies of existing pictures. The retouch menu is only displayed when a memory card containing photographs is inserted in the camera.

Option		Option	
 NEF (RAW) processing	230	 Monochrome	240
 Trim	232	 Image overlay	241
 Resize	233	 Color outline	243
 D-Lighting	235	 Photo illustration	244
 Quick retouch	236	 Color sketch	244
 Red-eye correction	236	 Miniature effect	245
 Straighten	237	 Selective color	246
 Distortion control	237	 Painting	248
 Perspective control	238	 Edit movie	146
 Fisheye	238	 Side-by-side comparison*	249
 Filter effects	239		



* Available only if retouch menu is displayed by pressing **i** and selecting **Retouch** when a retouched image or original is displayed in full-frame playback.

Creating Retouched Copies

To create a retouched copy:

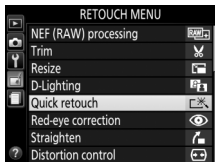
- 1 Display retouch options.**
Highlight the desired item in the retouch menu and press .





- 2 Select a picture.**
Highlight a picture and press  (to view the highlighted picture full screen, press and hold the  button).



Retouch

The camera may not be able to display or retouch images created with other devices. If the image was recorded at image quality settings of NEF (RAW) + JPEG ( 84), retouch options apply only to the RAW copy.

- 3 Select retouch options.**
For more information, see the section for the selected item. To exit without creating a retouched copy, press **MENU**.

- 4 Create a retouched copy.**
Press  to create a retouched copy. Except in the photo information “image only” page ( 156), retouched copies are indicated by a .



Creating Retouched Copies During Playback

To create a retouched copy of the picture currently displayed in full-frame playback (☐ 152), press **i**, then highlight **Retouch** and press **⏪** and select a retouch option (**Image overlay** excluded).

Retouching Copies

Most options can be applied to copies created using other retouch options, although with the exceptions of **Image overlay** and **Edit movie > Choose start/end point**, each option can be applied only once (note that multiple edits may result in loss of detail). Options that can not be applied to the current image are grayed out and unavailable.

Image Quality and Size

Except in the case of copies created with **Trim** and **Resize**, copies created from JPEG images are the same size and quality as the original, while copies created from NEF (RAW) photos are saved as large fine-quality JPEG images.

NEF (RAW) Processing

MENU button →  retouch menu



Create JPEG copies of NEF (RAW) photographs.

1 Select NEF (RAW) processing.

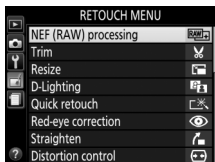
Highlight **NEF (RAW) processing** in the retouch menu and press  to display a picture selection dialog listing only NEF (RAW) images created with this camera.



2 Select a photograph.

Use the multi selector to highlight a photograph (to view the highlighted photograph full frame, press and hold the  button). Press  to select the highlighted photograph and proceed to the next step.

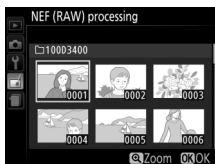

3 Choose settings for the JPEG copy.

Adjust the settings listed below. Note that white balance and vignette control are not available with pictures created with image overlay (📖 241), and that the effects of exposure compensation may differ from those that might have been expected when the photograph was taken.

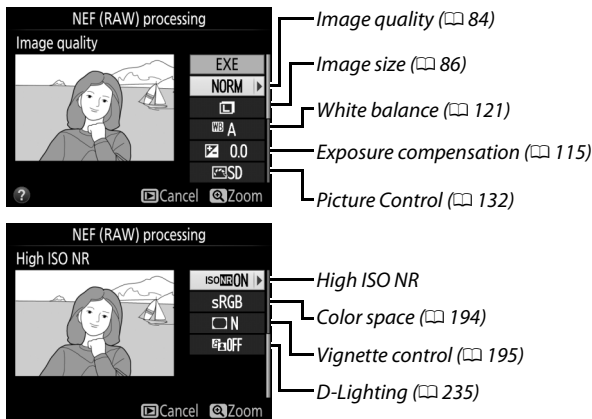

4 Copy the photograph.

Highlight **EXE** and press **OK** to create a JPEG copy of the selected photograph. To exit without copying the photograph, press the **MENU** button.



Trim

MENU button →  retouch menu

Create a cropped copy of the selected photograph. The selected photograph is displayed with the selected crop shown in yellow; create a cropped copy as described in the following table.









To	Use	Description
Increase size of crop		Press the  button to increase the size of the crop.
Reduce size of crop	 (?)	Press the  (?) button to reduce the size of the crop.
Change crop aspect ratio		Rotate the command dial to choose the aspect ratio.
Move crop		Use multi selector to position the crop. Press and hold to move the crop rapidly to the desired position.
Create copy		Save the current crop as a separate file.

Image Size

The size of the copy (which varies with crop size and aspect ratio) appears at upper left in the crop display.

Viewing Cropped Copies

Playback zoom may not be available when cropped copies are displayed.

See Also

See page 166 for information on cropping pictures during playback zoom.

Resize

MENU button →  retouch menu

Create small copies of selected photographs.

1 Select **Resize**.

To resize selected images, highlight **Resize** in the retouch menu and press .

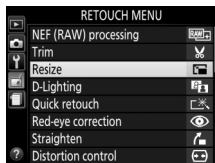

2 Choose a size.

Highlight **Choose size** and press .







Highlight an option and press .



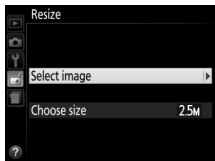

3 Choose pictures.

Highlight **Select image** and press .

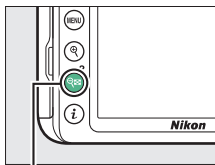

Highlight pictures using the multi selector and press the  (?) button to select or deselect (to view the highlighted picture full screen, press and hold the  button). Selected pictures are marked by a  icon. Press  when the selection is complete.



 (?) button



4 Save the resized copies.

A confirmation dialog will be displayed. Highlight **Yes** and press  to save the resized copies.

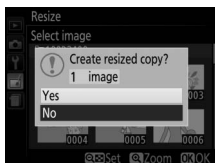

Viewing Resized Copies

Playback zoom may not be available when resized copies are displayed.

D-Lighting

MENU button →  retouch menu

D-Lighting brightens shadows, making it ideal for dark or backlit photographs.





Before



D-Lighting
(Portrait disabled)



D-Lighting
(Portrait enabled)

Press  or  to choose the amount of correction performed; the effect can be previewed in the edit display. Press  to copy the photograph.

■ ■ "Portrait"

To enable or disable this option, highlight **Portrait** and press . When **Portrait** is enabled, the camera will apply D-Lighting only to human portrait subjects, brightening up to three such subjects while leaving the background untouched for an effect similar to that achieved with a reflector.

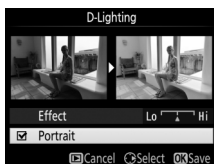



Portrait Subjects

The camera automatically selects up to three subjects for portrait D-Lighting (note that portrait D-Lighting can not be applied to photos taken with **Off** selected for **Auto image rotation** in the playback menu;  188). Depending on composition and how the subjects are posed, the desired results may not be achieved; if you are not satisfied, remove the check from **Portrait**.

Quick Retouch

MENU button →  retouch menu

Create copies with enhanced saturation and contrast. D-Lighting is applied as required to brighten dark or backlit subjects.

Press  or  to choose the amount of enhancement. Press  to copy the photograph.

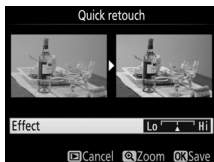



Red-Eye Correction

MENU button →  retouch menu

This option is used to correct “red-eye” caused by the flash, and is available only with photographs taken using the flash. The photograph selected for red-eye correction can be previewed in the edit display. Confirm the effects of red-eye correction and press  to create a copy. Note that red-eye correction may not always produce the expected results and may in very rare circumstances be applied to portions of the image that are not affected by red-eye; check the preview thoroughly before proceeding.

Straighten

MENU button →  retouch menu

Create a straightened copy of the selected image. Press  to rotate the image clockwise by up to five degrees in increments of approximately 0.25 degrees,  to rotate it counterclockwise (note that edges of the image will be trimmed to create a rectangular copy). Press  to save the retouched copy.

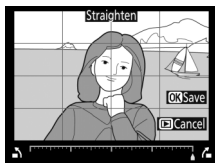



Distortion Control

MENU button →  retouch menu

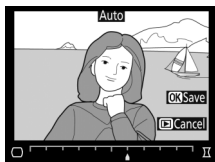
Create copies with reduced peripheral distortion. Select **Auto** to let the camera correct distortion automatically and then make fine adjustments using the multi selector, or select **Manual** to reduce distortion manually (note that **Auto** is not available with photos taken using auto distortion control; see page 196).



Press  to reduce barrel distortion,  to reduce pin-cushion distortion (note that greater amounts of distortion control result in more of the edges being cropped out). Press  to save the retouched copy.

Auto

Auto is for use only with pictures taken with type E and G lenses (fisheye, and certain other lenses excluded); results are not guaranteed with other lenses.

Perspective Control

MENU button →  retouch menu

Create copies that reduce the effects of perspective taken from the base of a tall object. Use the multi selector to adjust perspective (note that greater amounts of perspective control result in more of the edges being cropped out). Press **OK** to save the retouched copy.

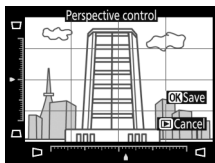

Before



After

Fisheye

MENU button →  retouch menu

Create copies that appear to have been taken with a fisheye lens. Press **▶** to increase the effect (this also increases the amount that will be cropped out at the edges of the image), **◀** to reduce it. Press **OK** to save the retouched copy.

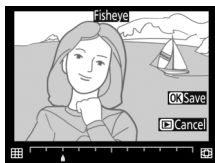

Filter Effects

MENU button →  retouch menu

After adjusting filter effects as described below, press **OK** to copy the photograph.

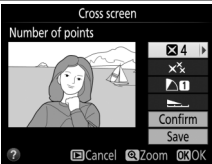
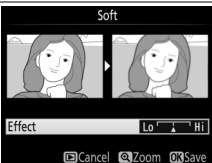

Option	Description
Skylight	Creates the effect of a skylight filter, making the picture less blue. 
Warm filter	Creates a copy with warm tone filter effects, giving the copy a “warm” red cast.
Cross screen	<p>Add starburst effects to light sources.</p> <ul style="list-style-type: none"> • Number of points: Choose from four, six, or eight. • Filter amount: Choose the brightness of the light sources affected. • Filter angle: Choose the angle of the points. • Length of points: Choose the length of points. • Confirm: Preview the effects of the filter. Press OK to preview the copy full frame. • Save: Create a retouched copy. 
Soft	<p>Add a soft filter effect. Press Left Arrow or Right Arrow to choose the filter strength.</p> 

Monochrome

MENU button →  retouch menu

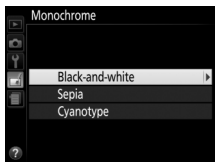
Copy photographs in **Black-and-white**, **Sepia**, or **Cyanotype** (blue and white monochrome).



Selecting **Sepia** or **Cyanotype** displays a preview of the selected image; press  to increase color saturation,  to decrease. Press  to create a monochrome copy.



Increase saturation



Decrease saturation

Image Overlay

MENU button →  retouch menu

Image overlay combines two existing NEF (RAW) photographs to create a single picture that is saved separately from the originals; the results, which make use of RAW data from the camera image sensor, are noticeably better than overlays created in an imaging application. The new picture is saved at current image quality and size settings; before creating an overlay, set image quality and size ( 84, 86; all options are available). To create an NEF (RAW) copy, choose an image quality of **NEF (RAW)**.



1 Select Image overlay.

Highlight **Image overlay** in the retouch menu and press .



The dialog shown at right will be displayed, with **Image 1** highlighted; press  to display a list of the NEF (RAW) pictures created with this camera.

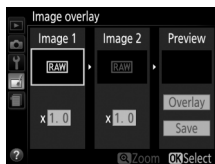

2 Select the first image.

Use the multi selector to highlight the first photograph in the overlay. To view the highlighted photograph full frame, press and hold the **Q** button. Press **OK** to select the highlighted photograph and return to the preview display.



3 Select the second image.

The selected image will appear as **Image 1**. Highlight **Image 2** and press **OK**, then select the second photo as described in Step 2.

4 Adjust gain.

Highlight **Image 1** or **Image 2** and optimize exposure for the overlay by pressing **▲** or **▼** to select gain from values between 0.1 and 2.0. Repeat for the second image. The default value is 1.0; select 0.5 to halve gain or 2.0 to double it. The effects of gain are visible in the **Preview** column.

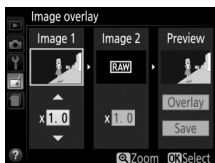

5 Preview the overlay.

To preview the composition as shown at right, press **◀** or **▶** to place the cursor in the Preview column, then press **▲** or **▼** to highlight **Overlay** and press **OK** (note that colors and brightness in the preview may differ from the final image). To save the overlay without displaying a preview, select **Save**. To return to Step 4 and select new photos or adjust gain, press **Q** (?).



6 Save the overlay.

Press **OK** while the preview is displayed to save the overlay. After an overlay is created, the resulting image will be displayed full-frame in the monitor.



Image Overlay

The overlay has the same photo info as the photograph selected for **Image 1**. The current image comment is appended to the overlay when it is saved; copyright information, however, is not copied.

Color Outline

MENU button →  retouch menu

Create an outline copy of a photograph to use as a base for painting. Press **OK** to save the retouched copy.

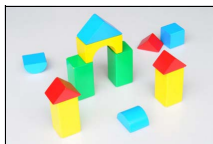

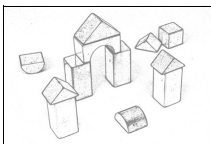

Before



After

Photo Illustration

MENU button →  retouch menu

Sharpen outlines and simplify coloring for a poster effect. Press  or  to make outlines thicker or thinner. Press  to save the retouched copy.

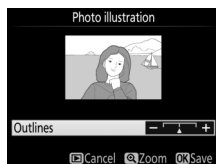





Before



After

Color Sketch

MENU button →  retouch menu











Create a copy of a photograph that resembles a sketch made with colored pencils. Press  or  to highlight **Vividness** or **Outlines** and press  or  to change. Vividness can be increased to make colors more saturated, or decreased for a washed-out, monochromatic effect, while outlines can be made thicker or thinner. Thicker outlines make colors more saturated. Press  to save the retouched copy.



Miniature Effect

MENU button →  retouch menu

Create a copy that appears to be a photo of a diorama. Works best with photos taken from a high vantage point. The area that will be in focus in the copy is indicated by a yellow frame.

To	Press	Description
Choose orientation	 (?)	Press  (?) to choose orientation of area that is in focus.
Choose area in focus		If area of effect is in wide orientation, press  or to position frame showing area of copy that will be in focus.
		If area of effect is in tall orientation, press  or to position frame showing area of copy that will be in focus.
Choose size		If area of effect is in wide orientation, press  or to choose height.
		If area of effect is in tall orientation, press  or to choose width.
Create copy		Create copy.

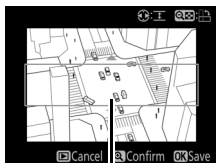

Area in focus





Selective Color

MENU button →  retouch menu





Create a copy in which only selected hues appear in color.

- 1 Select Selective color.**
Highlight **Selective color** in the retouch menu and press .





- 2 Select a photograph.**
Highlight a photograph and press  (to view the highlighted photograph full frame, press and hold the  button).

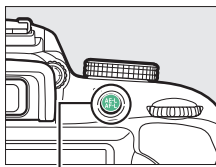

- 3 Select a color.**
Use the multi selector to position the cursor over an object and press  () to select the color of the object as one that will remain in the final copy (the camera may have difficulty detecting unsaturated colors; choose a saturated color). To zoom in on the picture for precise color selection, press . Press  (?) to zoom out.



 () button

Selected color



4 Highlight the color range.

Rotate the command dial to highlight the color range for the selected color.



Color range



5 Choose the color range.

Press or to increase or decrease the range of similar hues that will be included in the final photograph. Choose from values between 1 and 7; note that higher values may include hues from other colors.



6 Select additional colors.

To select additional colors, rotate the command dial to highlight another of the three color boxes at the top of the display and repeat Steps 3–5 to select another color. Repeat for a third color if desired. To deselect the highlighted color, press (to remove all colors, press and hold). A confirmation dialog will be displayed; select **Yes**).



7 Save the edited copy.

Press to copy the photograph.



Painting

MENU button →  retouch menu

Create a copy which emphasizes detail and color for a painterly effect. Press **OK** to save the retouched copy.

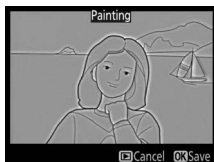

Before





After

Side-by-side Comparison

Compare retouched copies to the original photographs. This option is only available if the retouch menu is displayed by pressing the **i** button and selecting **Retouch** when a copy or original is played back full frame.

1 Select a picture.

Select a retouched copy (shown by a  icon) or a photograph that has been retouched in full-frame playback. Press **i**, then highlight **Retouch** and press .

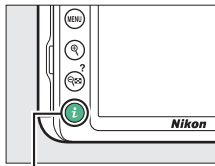

i button

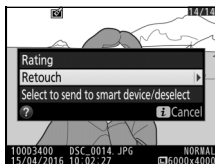









2 Select Side-by-side comparison.

Highlight **Side-by-side comparison** in the retouch menu and press .



3 Compare the copy with the original.

The source image is displayed on the left, the retouched copy on the right, with the options used to create the copy listed at the top of the display. Press  or  to switch between the source image and the retouched copy. To view the highlighted picture full frame, press and hold the  button. If the copy was created from two images using **Image overlay**, press  or  to view the other source image. If multiple copies exist for the current source image, press  or  to view the other copies. Press  to return to playback with the highlighted image displayed.

Options used to create copy

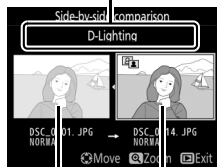

Source
image

Retouched
copy



Side-by-side comparison

The source image will not be displayed if the copy was created from a photograph that has since been deleted or that was protected when the copy was made ( 168).

Recent Settings



To display the recent settings menu, press **MENU** and select the  (recent settings) tab.

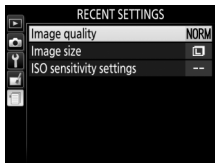

The recent settings menu lists the 20 most recently used settings. Press  or  to highlight an option and press  to select.



Removing Items from the Recent Settings Menu

To remove an item from the recent settings menu, highlight it and press the  button. A confirmation dialog will be displayed; press  again to delete the selected item.



Technical Notes

Read this chapter for information on compatible accessories, cleaning and storing the camera, and what to do if an error message is displayed or you encounter problems using the camera.

Compatible Lenses

Compatible CPU Lenses

This camera supports autofocus with AF-P and type E and G AF-S lenses only. AF-S lenses have names beginning with **AF-S** and AF-P lenses with **AF-P**; for information on determining lens type (D, E, G, or CPU), see page 253. Autofocus is not supported with other autofocus (AF) lenses. The following table lists the features available with compatible lenses in viewfinder photography:

Camera setting Lens ¹	Focus mode			Shooting mode		Metering system	
	AF	MF (with electronic rangefinder)	MF	M	Other modes		 
E type lens	✓	✓	✓	✓	✓	✓	✓ ²
Type G AF-S/AF-P NIKKOR	✓	✓	✓	✓	✓	✓	✓ ²
Type G AF NIKKOR	—	✓	✓	✓	✓	✓	✓ ²
D type lens	—	✓	✓	✓ ³	—	—	—
PC-E NIKKOR series ^{4,5}	—	✓ ⁶	✓	✓	✓	✓	✓ ²
PC Micro 85mm f/2.8D ⁷	—	✓ ⁶	✓	✓ ³	—	✓	✓ ²
Other AF NIKKOR (except lenses for F3AF)	—	✓ ⁸	✓	✓ ³	—	—	—
AI-P NIKKOR	—	✓ ⁹	✓	✓ ³	—	—	—

1 Assumes a combined aperture of f/5.6 or faster when AF-S teleconverter is attached.

2 Spot metering meters selected focus point ( 111).

3 Exposure indicator disabled.

- 4 The shift knob for the PC-E NIKKOR 24mm f/3.5D ED may contact the camera body when the lens is revolved.
 - 5 Shifting and/or tilting the lens interferes with exposure.
 - 6 Can not be used with shifting or tilting.
 - 7 Optimal exposure will only be achieved if the lens is at maximum aperture and the lens is not shifted or tilted.
 - 8 When AF 80–200mm f/2.8, AF 35–70mm f/2.8, AF 28–85mm f/3.5–4.5 (New), or AF 28–85mm f/3.5–4.5 lenses are zoomed all the way in at the minimum focus distance, the in-focus indicator (●) may be displayed when the image on the matte screen in the viewfinder is not in focus. Before shooting, confirm that the image in the viewfinder screen is in focus.
 - 9 With maximum aperture of f/5.6 or faster.
- Noise in the form of lines may appear during autofocus when movies are recorded at high ISO sensitivities. Use manual focus or focus lock.

✓ IX NIKKOR Lenses

IX NIKKOR lenses can not be used. Attempting to attach an IX NIKKOR lens could damage the lens or camera.

✓ Identifying CPU and Type G, E, and D Lenses

CPU lenses can be identified by the presence of CPU contacts, type G, E, and D lenses by a letter on the lens barrel. Type G and E lenses are not equipped with a lens aperture ring.

CPU contacts

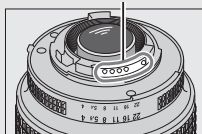

CPU lens

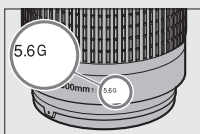

Type G or E lens

Aperture ring

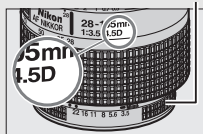

Type D lens

✓ Type D Lenses

Type D lenses may only be used when the camera is in mode **M**. Selecting another mode disables the shutter release. Aperture must be adjusted manually via the lens aperture ring and the camera metering system and i-TTL flash control can not be used.

Compatible Non-CPU Lenses

Non-CPU lenses may only be used when the camera is in mode **M**. Selecting another mode disables the shutter release.

Aperture must be adjusted manually via the lens aperture ring and the camera metering system, i-TTL flash control, and other features requiring a CPU lens can not be used. Some non-CPU lenses can not be used; see “Incompatible Accessories and Non-CPU Lenses,” below.

Camera setting Lens/accessory	Focus			Mode	
	AF	MF (with electronic rangefinder)	MF	M	Other modes
AI-, AI-modified NIKKOR or Nikon Series E lenses	—	✓ ¹	✓	✓ ²	—
Non-AI lenses	—	✓ ¹	✓	✓ ²	—
Medical NIKKOR 120mm f/4	—	✓	✓	✓ ^{2,3}	—
Reflex NIKKOR	—	—	✓	✓ ²	—
PC NIKKOR	—	✓ ⁴	✓	✓ ²	—
AI-type Teleconverter	—	✓ ⁵	✓	✓ ²	—
PB-6 Bellows Focusing Attachment ⁶	—	✓ ¹	✓	✓ ²	—
Auto extension rings (PK-series 11A, 12, or 13; PN-11)	—	✓ ¹	✓	✓ ²	—

1 With maximum aperture of f/5.6 or faster.

2 Exposure indicator can not be used.

3 Can be used at shutter speeds slower than flash sync speed by one step or more.

4 Can not be used with shifting or tilting.

5 With maximum effective aperture of f/5.6 or faster.

6 Attach in vertical orientation (can be used in horizontal orientation once attached).

Incompatible Accessories and Non-CPU Lenses

The following accessories and non-CPU lenses can NOT be used with the D3400:

- TC-16A AF teleconverter
- Lenses that require the AU-1 focusing unit (400mm f/4.5, 600mm f/5.6, 800mm f/8, 1200mm f/11)
- Fisheye (6mm f/5.6, 7.5mm f/5.6, 8mm f/8, OP 10mm f/5.6)
- 2.1cm f/4
- Extension Ring K2
- 180–600mm f/8 ED (serial numbers 174041–174180)
- 360–1200mm f/11 ED (serial numbers 174031–174127)
- 200–600mm f/9.5 (serial numbers 280001–300490)
- AF lenses for the F3AF (AF 80mm f/2.8, AF 200mm f/3.5 ED, AF Teleconverter TC-16)
- PC 28mm f/4 (serial number 180900 or earlier)
- PC 35mm f/2.8 (serial numbers 851001–906200)
- PC 35mm f/3.5 (old type)
- Reflex 1000mm f/6.3 (old type)
- Reflex 1000mm f/11 (serial numbers 142361–143000)
- Reflex 2000mm f/11 (serial numbers 200111–200310)

AF-Assist Illumination

The AF-assist illuminator has a range of about 0.5–3.0 m (1 ft 8 in.–9 ft 10 in.); when using the illuminator, use a lens with a focal length of 18–200 mm and remove the lens hood. AF-assist illumination is not available with the following lenses:

- AF-S NIKKOR 14–24mm f/2.8G ED
- AF-S NIKKOR 28–300mm f/3.5–5.6G ED VR
- AF-S DX NIKKOR 55–300mm f/4.5–5.6G ED VR
- AF-S VR Zoom-Nikkor 70–200mm f/2.8G IF-ED
- AF-S NIKKOR 70–200mm f/2.8G ED VR II
- AF-S Zoom-Nikkor 80–200mm f/2.8D IF-ED
- AF-S NIKKOR 80–400mm f/4.5–5.6G ED VR
- AF-S VR Nikkor 200mm f/2G IF-ED
- AF-S NIKKOR 200mm f/2G ED VR II
- AF-S VR Zoom-Nikkor 200–400mm f/4G IF-ED
- AF-S NIKKOR 200–400mm f/4G ED VR II
- AF-S NIKKOR 200–500mm f/5.6E ED VR

At ranges under 1 m (3 ft 4 in.), the following lenses may block the AF-assist illuminator and interfere with autofocus when lighting is poor:

- AF-S DX NIKKOR 10–24mm f/3.5–4.5G ED
- AF-S NIKKOR 16–35mm f/4G ED VR
- AF-S Zoom-Nikkor 17–35mm f/2.8D IF-ED
- AF-S DX Zoom-Nikkor 17–55mm f/2.8G IF-ED
- AF-S DX NIKKOR 18–105mm f/3.5–5.6G ED VR
- AF-S DX VR Zoom-Nikkor 18–200mm f/3.5–5.6G IF-ED
- AF-S DX NIKKOR 18–200mm f/3.5–5.6G ED VR II
- AF-S DX NIKKOR 18–300mm f/3.5–5.6G ED VR
- AF-S NIKKOR 24–70mm f/2.8G ED
- AF-S NIKKOR 24–70mm f/2.8E ED VR
- AF-S VR Zoom-Nikkor 24–120mm f/3.5–5.6G IF-ED
- AF-S NIKKOR 24–120mm f/4G ED VR
- AF-S NIKKOR 28mm f/1.8G
- AF-S Zoom-Nikkor 28–70mm f/2.8D IF-ED
- AF-S NIKKOR 35mm f/1.4G
- AF-S NIKKOR 70–200mm f/4G ED VR
- AF-P DX NIKKOR 70–300mm f/4.5–6.3G ED VR
- AF-P DX NIKKOR 70–300mm f/4.5–6.3G ED
- AF-S NIKKOR 85mm f/1.4G
- AF-S NIKKOR 85mm f/1.8G
- AF-S VR Micro-Nikkor 105mm f/2.8G IF-ED

The Built-in Flash

The built-in flash can be used with lenses with focal lengths of 18–300 mm, although in some cases the flash may be unable to entirely light the subject at some ranges or focal lengths due to shadows cast by the lens (see the illustration below), while lenses that block the subject's view of the red-eye reduction lamp may interfere with red-eye reduction. Remove lens hoods to prevent shadows.

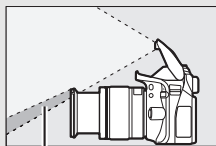

Shadow



Vignetting

The flash has a minimum range of 0.6 m and can not be used in the macro range of macro zoom lenses. The flash may be unable to light the entire subject with the following lenses at ranges less than those given below:

Lens	Zoom position	Minimum distance without vignetting
AF-S DX NIKKOR 10–24mm f/3.5–4.5G ED	24 mm	1.5 m / 5 ft
AF-S DX Zoom-Nikkor 12–24mm f/4G IF-ED	24 mm	1.0 m / 3 ft 4 in.
AF-S NIKKOR 16–35mm f/4G ED VR	35 mm	1.0 m / 3 ft 4 in.
AF-S DX NIKKOR 16–80mm f/2.8–4E ED VR	24 mm	1.0 m / 3 ft 4 in.
	35–80 mm	No vignetting
AF-S DX NIKKOR 16–85mm f/3.5–5.6G ED VR	24–85 mm	No vignetting
AF-S Zoom-Nikkor 17–35mm f/2.8D IF-ED	28 mm	1.0 m / 3 ft 4 in.
	35 mm	No vignetting

Lens	Zoom position	Minimum distance without vignetting
AF-S DX Zoom-Nikkor 17–55mm f/2.8G IF-ED	28 mm	1.5 m / 5 ft
	35 mm	1.0 m / 3 ft 4 in.
	45–55 mm	No vignetting
AF-S NIKKOR 18–35mm f/3.5–4.5G ED	24 mm	1.5 m / 5 ft
	28–35 mm	No vignetting
AF Zoom-Nikkor 18–35mm f/3.5–4.5D IF-ED	24 mm	1.0 m / 3 ft 4 in.
	28–35 mm	No vignetting
AF-P DX NIKKOR 18–55mm f/3.5–5.6G VR, AF-P DX NIKKOR 18–55mm f/3.5–5.6G	18 mm	1.0 m / 3 ft 4 in.
	24–55 mm	No vignetting
AF-S DX Zoom-Nikkor 18–70mm f/3.5–4.5G IF-ED	18 mm	1.0 m / 3 ft 4 in.
	24–70 mm	No vignetting
AF-S DX NIKKOR 18–105mm f/3.5–5.6G ED VR	18 mm	2.5 m / 8 ft 3 in.
	24 mm	1.0 m / 3 ft 4 in.
	35–105 mm	No vignetting
AF-S DX Zoom-Nikkor 18–135mm f/3.5–5.6G IF-ED	18 mm	2.0 m / 6 ft 7 in.
	24–135 mm	No vignetting
AF-S DX NIKKOR 18–140mm f/3.5–5.6G ED VR	24 mm	1.0 m / 3 ft 4 in.
	35–140 mm	No vignetting
AF-S DX VR Zoom-Nikkor 18–200mm f/3.5–5.6G IF-ED, AF-S DX NIKKOR 18–200mm f/3.5–5.6G ED VR II	24 mm	1.0 m / 3 ft 4 in.
	35–200 mm	No vignetting
AF-S DX NIKKOR 18–300mm f/3.5–5.6G ED VR	35 mm	1.5 m / 5 ft
	50 mm	1.0 m / 3 ft 4 in.
	105–300 mm	No vignetting
AF Zoom-Nikkor 20–35mm f/2.8D IF	24 mm	2.5 m / 8 ft 3 in.
	28 mm	1.0 m / 3 ft 4 in.
	35 mm	No vignetting
AF-S NIKKOR 24mm f/1.4G ED	24 mm	1.0 m / 3 ft 4 in.
AF-S NIKKOR 24–70mm f/2.8G ED	35 mm	1.5 m / 5 ft
	50–70 mm	No vignetting

Lens	Zoom position	Minimum distance without vignetting
AF-S NIKKOR 24–70mm f/2.8E ED VR	50 mm	1.0 m / 3 ft 4 in.
	70 mm	No vignetting
AF-S VR Zoom-Nikkor 24–120mm f/3.5–5.6G IF-ED	24 mm	1.0 m / 3 ft 4 in.
	28–120 mm	No vignetting
AF-S NIKKOR 24–120mm f/4G ED VR	24 mm	1.5 m / 5 ft
	28 mm	1.0 m / 3 ft 4 in.
	35–120 mm	No vignetting
AF-S Zoom-Nikkor 28–70mm f/2.8D IF-ED	35 mm	1.5 m / 5 ft
	50–70 mm	No vignetting
AF-S NIKKOR 28–300mm f/3.5–5.6G ED VR	28 mm	1.5 m / 5 ft
	35 mm	1.0 m / 3 ft 4 in.
	50–300 mm	No vignetting
AF-S VR Zoom-Nikkor 200–400mm f/4G IF-ED, AF-S NIKKOR 200–400mm f/4G ED VR II	200 mm	4.0 m / 13 ft 2 in.
	250 mm	3.0 m / 9 ft 11 in.
	300 mm	2.5 m / 8 ft 3 in.
PC-E NIKKOR 24mm f/3.5D ED*	24 mm	3.0 m / 9 ft 11 in.

* When not shifted or tilted.

When used with the AF-S NIKKOR 14–24mm f/2.8G ED, the flash will be unable to light the entire subject at all ranges.

Calculating Angle of View

The size of the area exposed by a 35mm camera is 36×24 mm. The size of the area exposed by the D3400, in contrast, is 23.5×15.6 mm, meaning that the angle of view of a 35mm camera is approximately 1.5 times that of the D3400. The approximate focal length of lenses for the D3400 in 35mm format can be calculated by multiplying the focal length of the lens by about 1.5.

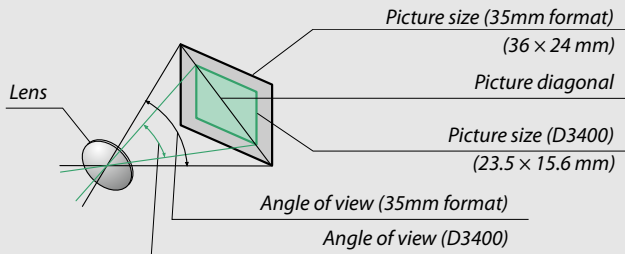

The Nikon Creative Lighting System (CLS)

Nikon's advanced Creative Lighting System (CLS) offers improved communication between the camera and compatible flash units for improved flash photography. The built-in flash will not fire when an optional flash unit is attached.

■ CLS-Compatible Flash Units

The following features are available with CLS-compatible flash units:

		SB-5000	SB-910, SB-900, SB-800	SB-700	SB-600	SB-500	SU-800	SB-R200	SB-400	SB-300	
Single flash	i-TTL	i-TTL balanced fill-flash for digital SLR ¹	✓	✓	✓	✓	✓	—	✓	✓	
		Standard i-TTL fill-flash for digital SLR	✓ ²	✓ ²	✓	✓ ²	✓	—	✓	✓	
	⊗A	Auto aperture	✓	✓ ³	—	—	—	—	—	—	
	A	Non-TTL auto	— ⁴	✓ ³	—	—	—	—	—	—	
	GN	Distance-priority manual	✓	✓	✓	—	—	—	—	—	
	M	Manual	✓	✓	✓	✓	✓ ⁵	—	✓ ⁵	✓ ⁵	
	RPT	Repeating flash	✓	✓	—	—	—	—	—	—	
Optical Advanced Wireless Lighting	Master	Remote flash control	✓	✓	✓	—	—	✓	—	—	
		i-TTL	✓	✓	✓	—	—	—	—	—	
		[A:B]	Quick wireless flash control	✓	—	✓	—	—	✓ ⁶	—	—
		⊗A	Auto aperture	✓	✓ ⁷	—	—	—	—	—	—
		A	Non-TTL auto	—	✓	—	—	—	—	—	—
		M	Manual	✓	✓	✓	—	—	—	—	—
		RPT	Repeating flash	✓	✓	—	—	—	—	—	—

			SB-5000	SB-910, SB-900, SB-800	SB-700	SB-600	SB-500	SU-800	SB-R200	SB-400	SB-300
Wireless Lighting	Optical Advanced Remote	i-TTL	✓	✓	✓	✓	✓	—	✓	—	—
		[A:B]	Quick wireless flash control	✓	✓	✓	✓	—	✓	—	—
		⊗A/A	Auto aperture/ Non-TTL auto	✓ ⁸	✓ ⁷	—	—	—	—	—	—
		M	Manual	✓	✓	✓	✓	—	✓	—	—
		RPT	Repeating flash	✓	✓	✓	✓	—	—	—	—
Radio-controlled Advanced Wireless Lighting			—	—	—	—	—	—	—	—	—
Color Information Communication (flash)			✓	✓	✓	✓	—	—	✓	✓	
Color Information Communication (LED light)			—	—	—	—	✓	—	—	—	—
AF-assist for multi-area AF			✓	✓	✓	✓	—	✓ ⁹	—	—	—
Red-eye reduction			✓	✓	✓	✓	—	—	✓	—	
Camera flash mode selection			—	—	—	—	✓	—	—	✓	✓
Camera flash unit firmware update			✓	✓ ¹⁰	✓	—	✓	—	—	—	✓

1 Not available with spot metering.

2 Can also be selected with flash unit.

3 ⊗A/A mode selection performed on flash unit using custom settings. "A" will be selected if lens is not type E or G.

4 "A" will be selected if lens is not type E or G.

5 Can only be selected with camera (□ 197).

6 Available only during close-up photography.

7 "A" will be selected if lens is not type E or G, regardless of mode selected with flash unit.

8 Choice of ⊗A and A depends on the option selected with master flash.

9 Available only in commander mode.

10 Firmware updates for the SB-910 and SB-900 can be performed from the camera.

The SU-800 wireless speedlight commander: When mounted on a CLS-compatible camera, the SU-800 can be used as a commander for SB-5000, SB-910, SB-900, SB-800, SB-700, SB-600, SB-500, or SB-R200 flash units in up to three groups. The SU-800 itself is not equipped with a flash.

■ Other Flash Units

The following flash units can be used in non-TTL auto and manual modes. Use with the camera in mode **S** or **M** and a shutter speed of $\frac{1}{200}$ s or slower selected.

Flash unit		SB-80DX, SB-28DX, SB-28, SB-26, SB-25, SB-24	SB-50DX ¹	SB-30, SB-27 ² , SB-22S, SB-22, SB-20, SB-16B, SB-15	SB-23, SB-29 ³ , SB-21B ³ , SB-29S ³
A	Non-TTL auto	✓	—	✓	—
M	Manual	✓	✓	✓	✓
	Repeating flash	✓	—	—	—
REAR	Rear-curtain sync⁴	✓	✓	✓	✓

- 1 Select mode **P**, **S**, **A**, or **M**, lower built-in flash, and use optional flash unit only.
- 2 Flash mode is automatically set to TTL and shutter-release is disabled. Set flash unit to **A** (non-TTL auto flash).
- 3 Autofocus is available with AF-S VR Micro-Nikkor 105mm f/2.8G IF-ED and AF-S Micro NIKKOR 60mm f/2.8G ED lenses only.
- 4 Available when camera is used to select flash mode.

The AS-15 Sync Terminal Adapter



When the AS-15 sync terminal adapter (available separately) is mounted on the camera accessory shoe, flash accessories can be connected via a sync cable.

Use Only Nikon Flash Accessories

Use only Nikon flash units. Negative voltages or voltages over 250 V applied to the accessory shoe could not only prevent normal operation, but damage the sync circuitry of the camera or flash. Before using a Nikon flash unit not listed in this section, contact a Nikon-authorized service representative for more information.

✔ Notes on Optional Flash Units

Refer to the Speedlight manual for detailed instructions. If the flash unit supports CLS, refer to the section on CLS-compatible digital SLR cameras. The D3400 is not included in the “digital SLR” category in the SB-80DX, SB-28DX, and SB-50DX manuals.

If an optional flash unit is attached in shooting modes other than ,  and  the flash will fire with every shot, even in modes in which the built-in flash can not be used.

i-TTL flash control can be used at ISO sensitivities between 100 and 12800. At high ISO sensitivities, noise (lines) may appear in photos taken with some optional flash units; if this occurs, choose a lower value. If the flash-ready indicator flashes for about three seconds after a photograph is taken, the flash has fired at full power and the photograph may be underexposed (CLS-compatible flash units only; for information on the exposure and flash charge indicators on other units, see the manual provided with the flash).

When an SC-series 17, 28, or 29 sync cable is used for off-camera flash photography, correct exposure may not be achieved in i-TTL mode. We recommend that you choose spot metering to select standard i-TTL flash control. Take a test shot and view the results in the monitor.

In i-TTL, use the flash panel or bounce adapter provided with the flash unit. Do not use other panels such as diffusion panels, as this may produce incorrect exposure.

If the controls on the optional SB-5000, SB-910, SB-900, SB-800, SB-700 or SB-600 flash unit or SU-800 wireless Speedlight commander are used to set flash compensation,  will appear in the information display.

The SB-5000, SB-910, SB-900, SB-800, SB-700, SB-600, SB-500, and SB-400 provide red-eye reduction, while the SB-5000, SB-910, SB-900, SB-800, SB-700, SB-600, and SU-800 provide AF-assist illumination with the following restrictions:

- **SB-5000:** In the case of 24–135 mm AF lenses, AF-assist illumination is available with the focus points shown at right.



- **SB-910 and SB-900:** In the case of 17–135 mm AF lenses, AF-assist illumination is available with the focus points shown at right.

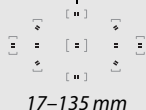

- **SB-800, SB-600, and SU-800:** In the case of 24–105 mm AF lenses, AF-assist illumination is available with the focus points shown at right.



- **SB-700:** In the case of 24–135 mm AF lenses, AF-assist illumination is available with the focus points shown at right.

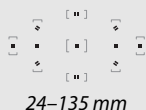

Depending on the lens used and scene recorded, the in-focus indicator (●) may be displayed when the subject is not in focus, or the camera may be unable to focus and the shutter release will be disabled.

Other Accessories

At the time of writing, the following accessories were available for the D3400.

Power sources	<ul style="list-style-type: none">• EN-EL14a Rechargeable Li-ion Battery (□ 12): Additional EN-EL14a batteries are available from local retailers and Nikon-authorized service representatives. EN-EL14 batteries can also be used.• MH-24 Battery Charger (□ 12): Recharge EN-EL14a and EN-EL14 batteries.• EP-5A Power Connector, EH-5b AC Adapter: These accessories can be used to power the camera for extended periods (EH-5a and EH-5 AC adapters can also be used). A power connector EP-5A is required to connect the camera to the EH-5b, EH-5a, or EH-5; see page 270 for details.
Filters	<ul style="list-style-type: none">• Filters intended for special-effects photography may interfere with autofocus or the electronic rangefinder.• The D3400 can not be used with linear polarizing filters. Use C-PL or C-PL II circular polarizing filters instead.• NC filters are recommended for protecting the lens.• To prevent ghosting, use of a filter is not recommended when the subject is framed against a bright light, or when a bright light source is in the frame.• Center-weighted metering is recommended with filters with exposure factors (filter factors) over 1 × (Y44, Y48, Y52, O56, R60, X0, X1, C-PL, ND2S, ND4, ND4S, ND8, ND8S, ND400, A2, A12, B2, B8, B12). See the filter manual for details.

Viewfinder eyepiece accessories	<ul style="list-style-type: none"> • DK-5 Eyepiece Cap (□ 68): Prevents light entering via the viewfinder from appearing in the photograph or interfering with exposure. • DK-20C Eyepiece Correction Lenses: Lenses are available with diopters of -5, -4, -3, -2, 0, $+0.5$, $+1$, $+2$, and $+3$ m^{-1} when the camera diopter adjustment control is in the neutral position (-1 m^{-1}). Use eyepiece correction lenses only if the desired focus can not be achieved with the built in diopter adjustment control (-1.7 to $+0.5$ m^{-1}). Test eyepiece correction lenses before purchase to ensure that the desired focus can be achieved. The rubber eyecup can not be used with eyepiece correction lenses. • DG-2 Magnifier: The DG-2 magnifies the scene displayed in the center of the viewfinder for greater precision during focusing. Eyepiece adapter required (available separately). • DK-22 Eyepiece Adapter: The DK-22 is used when attaching the DG-2 magnifier. • DR-6 Right-Angle Viewing Attachment: The DR-6 attaches at a right angle to the viewfinder eyepiece, allowing the image in the viewfinder to be viewed at right angles to the lens (for example, from directly above when the camera is horizontal).
Body cap	<p>BF-1B Body Cap/BF-1A Body Cap: The body cap keeps the mirror, viewfinder screen, and image sensor free of dust when a lens is not in place.</p>
Accessory shoe covers	<p>BS-1 Accessory Shoe Cover: A cover protecting the accessory shoe. The accessory shoe is used for optional flash units.</p>
USB cables	<p>UC-E20 USB Cable (□ 178, 181)</p>
HDMI cables	<p>HC-E1 HDMI Cable (□ 184): An HDMI cable with a type C connector for connection to the camera and a type A connector for connection to HDMI devices.</p>

Remote controls

ML-L3 Wireless Remote Control (📖 95): The ML-L3 uses a 3 V CR2025 battery.

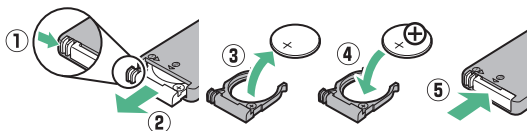

Pressing the battery-chamber latch to the right (①), insert a fingernail into the gap and open the battery chamber (②). Ensure that the battery is inserted in the correct orientation (④).

Approved Memory Cards

The camera supports SD, SDHC, and SDXC memory cards, including SDHC and SDXC cards compliant with UHS-I. Cards rated SD Speed Class 6 or better are recommended for movie recording; using slower cards may result in recording being interrupted. When choosing cards for use in card readers, be sure they are compatible with the device. Contact the manufacturer for information on features, operation, and limitations on use.



Optional Accessories

Availability may vary with country or region. See our website or brochures for the latest information.

Attaching a Power Connector and AC Adapter

Turn the camera off before attaching an optional power connector and AC adapter.

1 Ready the camera.

Open the battery-chamber cover (1) and power connector (2) covers.

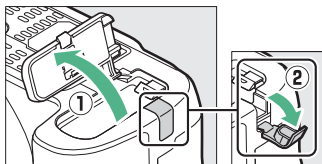

2 Insert the EP-5A power connector.

Be sure to insert the connector in the orientation shown, using the connector to keep the orange battery latch pressed to one side. Be sure the connector is fully inserted.

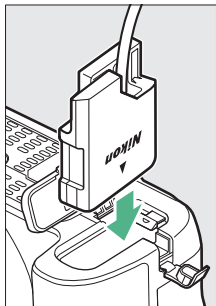

3 Close the battery-chamber cover.

Position the power connector cable so that it passes through the power connector slot and close the battery-chamber cover.

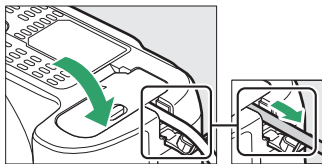

4 Connect the EH-5b AC adapter.

Connect the AC adapter power cable to the AC socket on AC adapter (3) and the power cable to the DC socket (4). A  icon is displayed in the monitor when the camera is powered by the AC adapter and power connector.

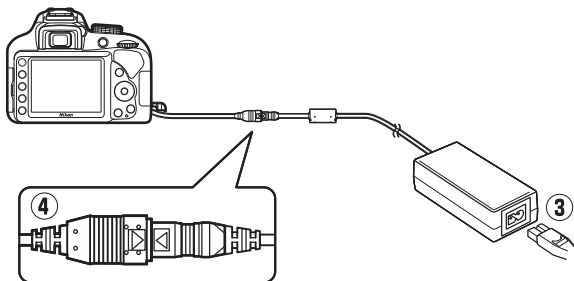

Caring for the Camera

Storage

When the camera will not be used for an extended period, remove the battery and store it in a cool, dry area with the terminal cover in place. To prevent mold or mildew, store the camera in a dry, well-ventilated area. Do not store your camera with naphtha or camphor moth balls or in locations that:

- are poorly ventilated or subject to humidities of over 60%
- are next to equipment that produces strong electromagnetic fields, such as televisions or radios
- are exposed to temperatures above 50 °C (122 °F) or below -10 °C (14 °F)

Cleaning

Camera body	Use a blower to remove dust and lint, then wipe gently with a soft, dry cloth. After using the camera at the beach or seaside, wipe off sand or salt with a cloth lightly dampened in distilled water and dry thoroughly. Important: <i>Dust or other foreign matter inside the camera may cause damage not covered under warranty.</i>
Lens, mirror, and viewfinder	These glass elements are easily damaged. Remove dust and lint with a blower. If using an aerosol blower, keep the can vertical to prevent the discharge of liquid. To remove fingerprints and other stains, apply a small amount of lens cleaner to a soft cloth and clean with care.
Monitor	Remove dust and lint with a blower. When removing fingerprints and other stains, wipe the surface lightly with a soft cloth or chamois leather. Do not apply pressure, as this could result in damage or malfunction.

Do not use alcohol, thinner, or other volatile chemicals.

Image Sensor Cleaning

If you suspect that dirt or dust on the image sensor is appearing in photographs, the sensor can be cleaned manually as described below. Note, however, that the sensor is extremely delicate and easily damaged. Nikon recommends that the sensor be cleaned only by Nikon-authorized service personnel.

1 Charge the battery.

A reliable power source is required when inspecting or cleaning the image sensor. Be sure the battery is fully charged before proceeding.

2 Remove the lens.

Turn the camera off and remove the lens.

3 Select **Lock mirror up for cleaning.**

Turn the camera on and highlight **Lock mirror up for cleaning** in the setup menu and press **▶** (note that this option is not available at battery levels of  or below).

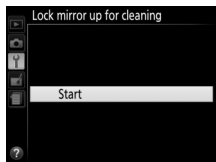

4 Press **OK.**

The message shown at right will be displayed in the monitor.

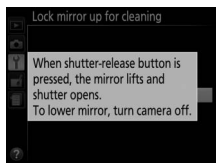

5 Raise the mirror.

Press the shutter-release button all the way down. The mirror will be raised and the shutter curtain will open, revealing the image sensor.



6 Examine the image sensor.

Holding the camera so that light falls on the image sensor, examine the interior of the camera for dust or lint. If no foreign objects are present, proceed to Step 8.

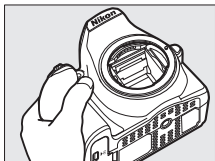

7 Clean the sensor.

Remove any dust and lint from the sensor with a blower. Do not use a blower-brush, as the bristles could damage the sensor. Dirt that can not be removed with a blower can only be removed by Nikon-authorized service personnel. Under no circumstances should you touch or wipe the sensor.

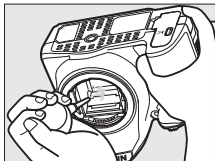

8 Turn the camera off.

The mirror will return to the down position and the shutter curtain will close. Replace the lens or body cap.

Use a Reliable Power Source

The shutter curtain is delicate and easily damaged. If the camera powers off while the mirror is raised, the curtain will close automatically. To prevent damage to the curtain, observe the following precautions:

- Do not turn the camera off or remove or disconnect the power source while the mirror is raised.
- If the battery runs low while the mirror is raised, a beep will sound and the self-timer lamp will flash to warn that the shutter curtain will close and the mirror will be lowered after about two minutes. End cleaning or inspection immediately.

Foreign Matter on the Image Sensor

Foreign matter entering the camera when lenses or body caps are removed or exchanged (or in rare circumstances lubricant or fine particles from the camera itself) may adhere to the image sensor, where it may appear in photographs taken under certain conditions. To protect the camera when no lens is in place, be sure to replace the body cap provided with the camera, being careful to first remove all dust and other foreign matter that may be adhering to the camera mount, lens mount, and body cap. Avoid attaching the body cap or exchanging lenses in dusty environments.

Should foreign matter find its way onto the image sensor, clean the sensor manually (📖 273) or have the sensor cleaned by authorized Nikon service personnel. Photographs affected by the presence of foreign matter on the sensor can be retouched using the clean image options available in some imaging applications.

Servicing the Camera and Accessories

The camera is a precision device and requires regular servicing. Nikon recommends that the camera be inspected by the original retailer or Nikon-authorized service representative once every one to two years, and that it be serviced once every three to five years (note that fees apply to these services). Frequent inspection and servicing are particularly recommended if the camera is used professionally. Any accessories regularly used with the camera, such as lenses or optional flash units, should be included when the camera is inspected or serviced.

Caring for the Camera and Battery: Cautions

Do not drop: The product may malfunction if subjected to strong shocks or vibration.

Keep dry: This product is not waterproof, and may malfunction if immersed in water or exposed to high levels of humidity. Rusting of the internal mechanism can cause irreparable damage.

Avoid sudden changes in temperature: Sudden changes in temperature, such as those that occur when entering or leaving a heated building on a cold day, can cause condensation inside the device. To prevent condensation, place the device in a carrying case or plastic bag before exposing it to sudden changes in temperature.

Keep away from strong magnetic fields: Do not use or store this device in the vicinity of equipment that generates strong electromagnetic radiation or magnetic fields. Strong static charges or the magnetic fields produced by equipment such as radio transmitters could interfere with the monitor, damage data stored on the memory card, or affect the product's internal circuitry.

Do not leave the lens pointed at the sun: Do not leave the lens pointed at the sun or other strong light source for an extended period. Intense light may cause the image sensor to deteriorate or produce a white blur effect in photographs.

Turn the product off before removing or disconnecting the power source: Do not unplug the product or remove the battery while the product is on or while images are being recorded or deleted. Forcibly cutting power in these circumstances could result in loss of data or in damage to product memory or internal circuitry. To prevent an accidental interruption of power, avoid carrying the product from one location to another while the AC adapter is connected.

Cleaning: When cleaning the camera body, use a blower to gently remove dust and lint, then wipe gently with a soft, dry cloth. After using the camera at the beach or seaside, wipe off any sand or salt using a cloth lightly dampened in pure water and then dry the camera thoroughly.

The lens and mirror are easily damaged. Dust and lint should be gently removed with a blower. When using an aerosol blower, keep the can vertical to prevent discharge of liquid. To remove fingerprints and other stains from the lens, apply a small amount of lens cleaner to a soft cloth and wipe the lens carefully.

See “Image Sensor Cleaning” (□ 273) for information on cleaning the image sensor.

Do not touch the shutter curtain: The shutter curtain is extremely thin and easily damaged. Under no circumstances should you exert pressure on the curtain, poke it with cleaning tools, or subject it to powerful air currents from a blower. These actions could scratch, deform, or tear the curtain.

Storage: To prevent mold or mildew, store the camera in a dry, well-ventilated area. If you are using an AC adapter, unplug the adapter to prevent fire. If the product will not be used for an extended period, remove the battery to prevent leakage and store the camera in a plastic bag containing a desiccant. Do not, however, store the camera case in a plastic bag, as this may cause the material to deteriorate. Note that desiccant gradually loses its capacity to absorb moisture and should be replaced at regular intervals.

To prevent mold or mildew, take the camera out of storage at least once a month. Turn the camera on and release the shutter a few times before putting it away.

Store the battery in a cool, dry place. Replace the terminal cover before putting the battery away.

Notes on the monitor: The monitor is constructed with extremely high precision; at least 99.99% of pixels are effective, with no more than 0.01% being missing or defective. Hence while these displays may contain pixels that are always lit (white, red, blue, or green) or always off (black), this is not a malfunction and has no effect on images recorded with the device.

Images in the monitor may be difficult to see in a bright light.

Do not apply pressure to the monitor, as this could cause damage or malfunction. Dust or lint on the monitor can be removed with a blower. Stains can be removed by wiping lightly with a soft cloth or chamois leather. Should the monitor break, care should be taken to avoid injury from broken glass and to prevent liquid crystal from the monitor touching the skin or entering the eyes and mouth.

Moiré: Moiré is an interference pattern created by the interaction of an image containing a regular, repeating grid, such as the pattern of weave in cloth or windows in a building, with the camera image sensor grid. If you notice moiré in your photographs, try changing the distance to the subject, zooming in and out, or changing the angle between the subject and the camera.

The battery and charger: Batteries may leak or explode if improperly handled. Read and follow the warnings and cautions on pages xi–xiv of this manual. Observe the following precautions when handling batteries and chargers:

- Use only batteries approved for use in this equipment.
- Do not expose the battery to flame or excessive heat.
- Keep the battery terminals clean.
- Turn the product off before replacing the battery.
- Remove the battery from the camera or charger when not in use and replace the terminal cover. These devices draw minute amounts of charge even when off and could draw the battery down to the point that it will no longer function. If the battery will not be used for some time, insert it in the camera and run it flat before removing it and storing it in a location with an ambient temperature of 15 °C to 25 °C (59 °F to 77 °F; avoid hot or extremely cold locations). Repeat this process at least once every six months.

- Turning the camera on and off repeatedly when the battery is fully discharged will shorten battery life. Batteries that have been fully discharged must be charged before use.
- The internal temperature of the battery may rise while the battery is in use. Attempting to charge the battery while the internal temperature is elevated will impair battery performance, and the battery may not charge or charge only partially. Wait for the battery to cool before charging.
- Charge the battery indoors at ambient temperatures of 5 °C–35 °C (41 °F–95 °F). Do not use the battery at ambient temperatures below 0 °C (32 °F) or above 40 °C (104 °F); failure to observe this precaution could damage the battery or impair its performance. Capacity may be reduced and charging times may increase at battery temperatures from 0 °C (32 °F) to 15 °C (59 °F) and from 45 °C (113 °F) to 60 °C (140 °F). The battery will not charge if its temperature is below 0 °C (32 °F) or above 60 °C (140 °F).
- If the **CHARGE** lamp flashes quickly (about eight times a second) during charging, confirm that the temperature is in the correct range and then unplug the charger and remove and reinsert the battery. If the problem persists, cease use immediately and take battery and charger to your retailer or a Nikon-authorized service representative.
- Do not move the charger or touch the battery during charging. Failure to observe this precaution could in very rare instances result in the charger showing that charging is complete when the battery is only partially charged. Remove and reinsert the battery to begin charging again.
- Continuing to charge the battery after it is fully charged can impair battery performance.
- A marked drop in the time a fully charged battery retains its charge when used at room temperature indicates that it requires replacement. Purchase a new EN-EL14a battery.
- Use the charger with compatible batteries only. Unplug when not in use.
- Do not short the charger terminals. Failure to observe this precaution could result in overheating and damage to the charger.

- Charge the battery before use. When taking photographs on important occasions, ready a spare battery and keep it fully charged. Depending on your location, it may be difficult to purchase replacement batteries on short notice. Note that on cold days, the capacity of batteries tends to decrease. Be sure the battery is fully charged before taking photographs outside in cold weather. Keep a spare battery in a warm place and exchange the two as necessary. Once warmed, a cold battery may recover some of its charge.
- Used batteries are a valuable resource; recycle in accord with local regulations.

Available Settings

The following table lists the settings that can be adjusted in each mode. Note that some settings may be unavailable depending on the options selected.

Shooting menu	ISO sensitivity	—	—	✓	✓ ¹	✓ ¹	—	✓ ¹	✓ ¹	✓ ¹	✓ ¹	✓ ¹	
	White balance	—	—	✓	—	—	—	—	—	—	—	—	
	Set Picture Control	—	—	✓	—	—	—	—	—	—	—	—	
	Active D-Lighting	— ²	— ²	✓	— ²	— ²	—	—	— ²	—	—	—	
	Noise reduction	✓	✓	✓	✓	✓	—	✓	✓	✓	✓	✓	
	Focus mode (viewfinder)	✓	✓	✓	✓	✓	—	✓	✓	✓	✓	✓	
	Focus mode (live view/movie)	✓	✓	✓	✓	✓	✓	✓	✓	✓	✓	✓	
	AF-area mode (viewfinder)	✓	✓	✓	✓	✓	—	✓	✓	✓	—	✓	✓
	AF-area mode (live view/movie)	—	—	✓	✓	✓	✓ ³	✓	✓ ³	✓ ³	—	✓ ³	✓
	Built-in AF-assist illuminator	✓	✓	✓	✓	—	—	✓	✓	✓	—	✓	✓
	Metering	—	—	✓	—	—	—	—	—	—	—	—	—
Flash ctrl for built-in flash/Optional flash	—	—	✓	—	—	—	—	—	—	—	—	—	
Other settings	Flash compensation	—	—	✓	✓	✓	—	—	—	—	—	—	
	Exposure compensation	—	—	✓	✓	✓	✓	—	—	—	—	—	
	Flash mode	✓	—	✓	✓	—	—	✓	✓	✓	—	—	

1 **Auto ISO sensitivity control** is not available.

2 Fixed at **On**.

3 Subject-tracking AF is not available.

Troubleshooting

If the camera fails to function as expected, check the list of common problems below before consulting your retailer or Nikon-authorized service representative.

Battery/Display

The camera is on but does not respond: Wait for recording to end. If the problem persists, turn the camera off. If the camera does not turn off, remove and reinsert the battery or, if you are using an AC adapter, disconnect and reconnect the AC adapter. Note that although any data currently being recorded will be lost, data that have already been recorded will not be affected by removing or disconnecting the power source.

The camera takes time to turn off: The camera is performing an image sensor check. Do not remove the battery or disconnect the AC adapter until the camera has turned off.

Viewfinder is out of focus: Adjust viewfinder focus (☐ 26). If this does not correct the problem, select single-servo autofocus (**AF-S**; ☐ 69), single-point AF ([*]; ☐ 74), and the center focus point, and then frame a high-contrast subject in the center focus point and press the shutter-release button halfway to focus the camera. With the camera in focus, use the diopter adjustment control to bring the subject into clear focus in the viewfinder. If necessary, viewfinder focus can be further adjusted using optional corrective lenses (☐ 268).

Displays turn off without warning: Choose longer delays for **Auto off timers** (☐ 207).

Information display does not appear in monitor: Shutter-release button is pressed halfway. If information display does not appear when you remove your finger from shutter-release button, confirm that **On** is selected for **Auto info display** (☐ 206) and that battery is charged.

Viewfinder display is unresponsive and dim: The response times and brightness of this display vary with temperature.

Shooting (All Modes)

Camera takes time to turn on: Delete files or folders.

Shutter-release disabled:

- Memory card is locked, full, or not inserted (☐ 13, 292).
 - **Release locked** is selected for **Slot empty release lock** (☐ 226) and no memory card is inserted (☐ 13).
 - Built-in flash is charging (☐ 38).
 - Camera is not in focus (☐ 35).
 - The attached lens is not type E or G and the camera is not in mode **M** (☐ 253).
-

Only one shot taken each time shutter-release button is pressed in continuous shooting mode: Continuous shooting is not available if built-in flash fires (☐ 64, 87).

Final photo is larger than area shown in viewfinder: Viewfinder horizontal and vertical frame coverage is approximately 95%.

Photos are out of focus:

- The attached lens can not be used with autofocus: focus manually or switch to a lens that can be used with autofocus (☐ 81, 253).
 - Camera unable to focus using autofocus: use manual focus or focus lock (☐ 72, 79, 81).
 - Camera is in manual focus mode: focus manually (☐ 81).
-

Focus does not lock when shutter-release button is pressed halfway: Use $\overline{\text{AE-L}}$ (☐) button to lock focus when live view is off and **AF-C** is selected for focus mode or when photographing moving subjects in **AF-A** mode (☐ 79).

Can not select focus point:

- **[] (Auto-area AF;** ☐ 74) is selected: choose another AF-area mode.
 - Press shutter-release button halfway to start standby timer (☐ 37).
-

Can not select AF-area mode: Manual focus selected (☐ 69, 81).

AF-assist illuminator does not light:



- AF-assist illuminator does not light if **AF-C** is selected for autofocus mode (☐ 69) or if continuous-servo autofocus is selected when the camera is in **AF-A** mode. Choose **AF-S**. If an option other than  (Auto-area AF) is selected for AF-area mode, select center focus point (☐ 74, 76).
- The camera is currently in live view.
- **Off** is selected for **Built-in AF-assist illuminator** (☐ 196).
- Illuminator has turned off automatically. Illuminator may become hot with continued use; wait for it to cool down.

Image size can not be changed: Image quality set to NEF (RAW) (☐ 85).

Camera is slow to record photos:

- Depending on shooting conditions and memory card performance, access lamp may light for up to about a minute after shooting ends in continuous release mode.
 - Turn noise reduction off (☐ 195).
-

Noise (bright spots, randomly-spaced bright pixels, fog, or lines) appears in photos:

- Bright spots, randomly-spaced bright pixels, fog, and lines can be reduced by lowering ISO sensitivity.
- Use the **Noise reduction** option in the shooting menu to limit the occurrence of bright spots or fog in photos taken at shutter speeds slower than 1 s (☐ 195).
- Fog and bright spots may indicate that the camera's internal temperature has become elevated due to high ambient temperatures, long exposures, or similar causes: turn the camera off and wait for it to cool before resuming shooting.
- At high ISO sensitivities, lines may appear in photos taken with some optional flash units; if this occurs, choose a lower value.
- At high ISO sensitivities, including high values selected with auto ISO sensitivity control, randomly-spaced bright pixels can be reduced by turning **Noise reduction** on (☐ 195).
- At high ISO sensitivities, bright spots, randomly-spaced bright pixels, fog, or lines may be more noticeable in long exposures, and photos taken at high ambient temperatures or with Active D-Lighting enabled, **Flat** selected for **Set Picture Control** (☐ 132) or extreme values selected for Picture Control parameters (☐ 135).
- In  mode, randomly-spaced bright pixels, fog, or lines may be more noticeable in pictures shot under low light.

No photo taken when remote control shutter-release button is pressed:

- Replace battery in remote control (☐ 269).
- Choose remote control release mode (☐ 95).
- Flash is charging (☐ 38).
- Time selected for **Remote on duration (ML-L3)** (☐ 208) has elapsed.
- Bright light is interfering with ML-L3 remote control.

Beep does not sound:

- **Off** is selected for **Beep** (☐ 213).
 - Camera is in quiet shutter-release mode (☐ 65), or movie is being recorded (☐ 138).
 - **MF** or **AF-C** is selected as the focus mode or subject moves when **AF-A** is selected (☐ 69).
-

Smudges appear in photographs: Clean front and rear lens elements. If problem persists, clean the image sensor manually (☞ 273) or contact a Nikon-authorized service representative.

Date is not imprinted on photos: An NEF (RAW) option is selected for image quality (☞ 85, 202).

Sound is not recorded with movies: Microphone off is selected for **Movie settings > Microphone** (☞ 141).

Live view ends unexpectedly or does not start: Live view may end automatically to prevent damage to the camera's internal circuits if:

- The ambient temperature is high
 - The camera has been used for extended periods in live view or to record movies
 - The camera has been used in continuous release modes for extended periods. If live view does not start when you attempt to start live view, wait for the internal circuits to cool and then try again. Note that the camera may feel warm to the touch, but this does not indicate a malfunction.
-

Image artifacts appear during live view: "Noise" (randomly-spaced bright pixels, fog, or lines) and unexpected colors may appear if you zoom in on the view through the lens (☞ 38) during live view; in movies, the amount and distribution of randomly-spaced bright pixels, fog, and bright spots are affected by frame size and rate (☞ 141). Randomly-spaced bright pixels, fog, or bright spots may also arise as a result of increases in the temperature of the camera's internal circuits during live view; exit live view when the camera is not in use.

Flicker or banding appears during live view or movie recording: Choose an option for **Flicker reduction** that matches the frequency of the local AC power supply (☞ 213).

Bright bands appear during live view or movie recording: A flashing sign, flash, or other light source with brief duration was used during live view or movie recording.

Menu item can not be selected: Some options are not available in all modes.

Shooting (P, S, A, M)

Shutter-release disabled:

- The attached lens is not type E or G: rotate camera mode dial to **M** (☞ 105, 253).
 - Mode dial rotated to **S** after shutter speed of “Bulb” or “Time” selected in mode **M**: choose new shutter speed (☞ 101).
-

Full range of shutter speeds not available:

- Flash in use (☞ 91).
 - When **On** is selected for **Movie settings > Manual movie settings** in the shooting menu, the range of available shutter speeds varies with the frame rate (☞ 142).
-

Can not select desired aperture: Range of available apertures varies with lens used.

Colors are unnatural:

- Adjust white balance to match light source (☞ 121).
 - Adjust **Set Picture Control** settings (☞ 132).
-

Can not measure white balance: Subject is too dark or too bright (☞ 128).

Image can not be selected as source for preset white balance: Image was not created with D3400 (☞ 130).

Effects of Picture Control differ from image to image: **A** (auto) is selected for sharpening, clarity, contrast, or saturation. For consistent results over a series of photos, choose another setting (☞ 136).

Metering can not be changed: Autoexposure lock is in effect (☞ 113).

Exposure compensation can not be used: Camera is in mode **M**. Choose another mode (☞ 98, 116).

Noise (reddish areas or other artifacts) appears in long time-exposures: Turn noise reduction on (☞ 195).

Playback

NEF (RAW) image is not played back: Photo was taken at image quality of NEF (RAW)+JPEG (☞ 84).

Can not view pictures recorded with other cameras: Pictures recorded with other makes of camera may not be displayed correctly.

Some pictures are not displayed during playback: Select **All** for **Playback folder** (☞ 187).

“Tall” (portrait) orientation photos are displayed in “wide” (landscape) orientation:

- Select **On** for **Rotate tall** (☞ 189).
 - Photo was taken with **Off** selected for **Auto image rotation** (☞ 188).
 - Photo is displayed in image review (☞ 188, 189).
 - Camera was pointed up or down when photo was taken (☞ 188).
-

Can not delete picture:

- Picture is protected: remove protection (☞ 168).
 - Memory card is locked (☞ 291).
-

Can not retouch picture: Photo can not be further edited with this camera (☞ 228).

Can not select photo for printing: Photo is in NEF (RAW) format. Transfer photos to computer and print using Capture NX-D (☞ 177). NEF (RAW) photos can be saved in JPEG format using **NEF (RAW) processing** (☞ 230).

Picture is not displayed on TV: HDMI (☞ 184) cable is not correctly connected.

Camera does not respond to remote control for HDMI-CEC television:

- Select **On** for **HDMI > Device control** in the setup menu (☞ 185).
 - Adjust HDMI-CEC settings for the television as described in documentation provided with the device.
-

Can not transfer photos to computer: OS not compatible with camera or transfer software. Use card reader to copy photos to computer (☞ 177).

Computer displays NEF (RAW) images differently from camera: Third-party software does not display effects of Picture Controls, Active D-Lighting, or vignette control. Use Capture NX-D (☞ 177).

Bluetooth

The memory card access lamp (☐ 36) lights when the camera is off: The camera is transmitting data to a smart device. This is not a malfunction.

Can not connect to wireless printers and other wireless devices: This camera can connect only to devices to which the SnapBridge app has been installed.

Miscellaneous



Date of recording is not correct: Set camera clock (☐ 25, 205).









Menu item can not be selected: Some options are not available at certain combinations of settings or when no memory card is inserted (☐ 13, 227, 281).

Error Messages

This section lists the indicators and error messages that appear in the viewfinder and monitor.



Warning Icons

A flashing  in the monitor or  in the viewfinder indicates that a warning or error message can be displayed in the monitor by pressing the  (?) button.

Indicator		Solution	
Monitor	Viewfinder		
Lens not attached	 (flashes)	<ul style="list-style-type: none"> • Attach compatible lens. • If lens is not type E or G, select mode M. 	252 105
Before taking photos, rotate the zoom ring to extend the lens.	 (flashes)	A lens with a retractable lens barrel button is attached with the lens barrel retracted. Press the retractable lens barrel button and rotate the zoom ring to extend the lens.	16
Shutter release disabled. Recharge battery.	 (flashes)	Turn camera off and recharge or replace battery.	12, 13
This battery cannot be used. It does not communicate properly with this camera. To use the camera safely, choose a battery designated for use in this camera.	 (flashes)	Use Nikon-approved battery.	267
Initialization error. Turn camera off and then on again.	 (  ) (flashes)	Turn camera off, remove and replace battery, and then turn camera on again.	13, 18

Indicator		Solution	📖
Monitor	Viewfinder		
Battery level is low. Complete operation and turn camera off immediately.	—	End cleaning and turn camera off and recharge or replace battery.	275
Clock not set	⌚ (flashes)	Set camera clock.	25, 205
No memory card inserted	(- E -)/⌚ (flashes)	Turn camera off and confirm that card is correctly inserted.	13
Memory card is locked. Slide lock to “write” position.	⌚ d (flashes)	Memory card is locked (write protected). Slide card write-protect switch to “write” position.	—
This memory card cannot be used. Card may be damaged. Insert another card.	⌚ d/(E r r) (flashes)	<ul style="list-style-type: none"> • Use approved card. • Format card. If problem persists, card may be damaged. Contact Nikon-authorized service representative. • Error creating new folder. Delete files or insert new memory card. • Insert new memory card. • Eye-Fi card is still emitting wireless signal after Disable has been selected for Eye-Fi upload. To terminate wireless transmission, turn the camera off and remove the card. 	269 201 13, 171 13 224
		Not available if Eye-Fi card is locked.	⌚ d/(E r r) (flashes)
This card is not formatted. Format the card.	(F o r) (flashes)	Format card or turn camera off and insert new memory card.	13, 201

Indicator		Solution	📖
Monitor	Viewfinder		
Card is full	FuL/G/? (flashes)	<ul style="list-style-type: none"> • Reduce quality or size. • Delete photographs. • Insert new memory card. 	84 171 13
—	● (flashes)	Camera can not focus using autofocus. Change composition or focus manually.	35, 72, 81
Subject is too bright	? (flashes)	<ul style="list-style-type: none"> • Use a lower ISO sensitivity. • Use commercial ND filter. • In mode: <ul style="list-style-type: none"> S Increase shutter speed A Choose a smaller aperture (higher f-number) ? Choose another shooting mode 	93 267 102 104 5
Subject is too dark		<ul style="list-style-type: none"> • Use a higher ISO sensitivity. • Use flash. • In mode: <ul style="list-style-type: none"> S Lower shutter speed A Choose a larger aperture (lower f-number) 	93 87 102 104
No “Bulb” in S mode	b u l b / ? (flashes)	Change shutter speed or select mode M.	102, 105
No “Time” in S mode	- - / ? (flashes)		
—	⚡ (flashes)	Flash has fired at full power. Check photo in monitor; if underexposed, adjust settings and try again.	—

Indicator		Solution	📖
Monitor	Viewfinder		
—	 (flashes)	<ul style="list-style-type: none"> • Use the flash. • Change distance to subject, aperture, flash range, or ISO sensitivity. • Lens focal length is less than 18 mm: use a longer focal length. • Optional SB-400 or SB-300 flash unit attached: flash is in bounce position or focus distance is very short. Continue shooting; if necessary, increase focus distance to prevent shadows from appearing in photograph. 	87 92, 93, 104 — —
Error. Press shutter release button again.	 (flashes)	Release shutter. If error persists or appears frequently, consult Nikon-authorized service representative.	—
Start-up error. Contact a Nikon-authorized service representative.		Consult Nikon-authorized service representative.	—
Metering error			
Unable to start live view. Please wait for camera to cool.	—	Wait for the internal circuits to cool before resuming live view or movie recording.	286
Folder contains no images.	—	Folder selected for playback contains no images. Select folder containing images from Playback folder menu or insert memory card containing images.	13, 187







Indicator		Solution	📖
Monitor	Viewfinder		
Cannot display this file.	—	File can not be played back on camera.	—
Cannot select this file.	—	Images created with other devices can not be retouched.	228
This movie cannot be edited.	—	• Movies created with other devices can not be edited.	138
		• Movies must be at least two seconds long.	149
No image for retouching.	—	Memory card does not contain NEF (RAW) images for use with NEF (RAW) processing .	230
Network access not available until camera cools.	—	Turn camera off and try again after waiting for camera to cool.	—
Check printer.	—	Check printer. To resume, select Continue (if available).	—*
Check paper.	—	Paper is not selected size. Insert paper of correct size and select Continue .	—*
Paper jam.	—	Clear jam and select Continue .	—*
Out of paper.	—	Insert paper of selected size and select Continue .	—*
Check ink supply.	—	Check ink. To resume, select Continue .	—*
Out of ink.	—	Replace ink and select Continue .	—*

* See printer manual for more information.



Specifications



■ ■ Nikon D3400 Digital Camera

Type	
Type	Single-lens reflex digital camera
Lens mount	Nikon F mount (with AF contacts)
Effective angle of view	Nikon DX format; focal length equivalent to approx. 1.5× that of lenses with FX format angle of view
Effective pixels	
Effective pixels	24.2 million
Image sensor	
Image sensor	23.5 × 15.6 mm CMOS sensor
Total pixels	24.72 million
Dust-reduction System	Image Dust Off reference data (Capture NX-D software required)
Storage	
Image size (pixels)	<ul style="list-style-type: none">• 6000 × 4000 (Large)• 4496 × 3000 (Medium)• 2992 × 2000 (Small)
File format	<ul style="list-style-type: none">• NEF (RAW): 12 bit, compressed• JPEG: JPEG-Baseline compliant with fine (approx. 1 : 4), normal (approx. 1 : 8), or basic (approx. 1 : 16) compression• NEF (RAW)+JPEG: Single photograph recorded in both NEF (RAW) and JPEG formats
Picture Control System	Standard, Neutral, Vivid, Monochrome, Portrait, Landscape, Flat; selected Picture Control can be modified
Media	SD (Secure Digital) and UHS-I compliant SDHC and SDXC memory cards
File system	DCF 2.0, Exif 2.3, PictBridge

Viewfinder	
Viewfinder	Eye-level pentamirror single-lens reflex viewfinder
Frame coverage	Approx. 95% horizontal and 95% vertical
Magnification	Approx. $0.85 \times$ (50 mm f/1.4 lens at infinity, -1.0 m^{-1})
Eyepoint	18 mm (-1.0 m^{-1} ; from center surface of viewfinder eyepiece lens)
Diopter adjustment	$-1.7 - +0.5 \text{ m}^{-1}$
Focusing screen	Type B BriteView Clear Matte Mark VII screen
Reflex mirror	Quick return
Lens aperture	Instant return, electronically controlled
Lens	
Autofocus support	Autofocus is available with AF-P and type E and G AF-S lenses.
Shutter	
Type	Electronically-controlled vertical-travel focal-plane shutter
Speed	$\frac{1}{4000} - 30 \text{ s}$ in steps of $\frac{1}{3} \text{ EV}$; Bulb; Time
Flash sync speed	$X = \frac{1}{200} \text{ s}$; synchronizes with shutter at $\frac{1}{200} \text{ s}$ or slower
Release	
Release mode	 (single frame),  (continuous),  (quiet shutter release),  (self-timer),  2s (delayed remote; ML-L3),  (quick-response remote; ML-L3)
Frame advance rate	Up to 5 fps Note: Frame rates assume manual focus, manual or shutter-priority auto exposure, a shutter speed of $\frac{1}{250} \text{ s}$ or faster, and other settings at default values.
Self-timer	2 s, 5 s, 10 s, 20 s; 1–9 exposures

Exposure	
Metering	TTL exposure metering using 420-pixel RGB sensor
Metering method	<ul style="list-style-type: none"> • Matrix metering: 3D color matrix metering II (type E and G lenses) • Center-weighted metering: Weight of 75% given to 8-mm circle in center of frame • Spot metering: Meters 3.5-mm circle (about 2.5% of frame) centered on selected focus point
Range (ISO 100, f/1.4 lens, 20 °C/68 °F)	<ul style="list-style-type: none"> • Matrix or center-weighted metering: 0–20 EV • Spot metering: 2–20 EV
Exposure meter coupling	CPU
Mode	Auto modes (📷 auto; Ⓜ auto, flash off); programmed auto with flexible program (P); shutter-priority auto (S); aperture-priority auto (A); manual (M); scene modes (👤 portrait; 🏞 landscape; 👦 child; 🏃 sports; 🌻 close up; 🌃 night portrait); special effects modes (🌃 night vision; VI super vivid; POP pop; 🎨 photo illustration; 📷 toy camera effect; 🏠 miniature effect; 🖌 selective color; 🖤 silhouette; 🏠 high key; 🌑 low key)
Exposure compensation	Can be adjusted by –5 – +5 EV in increments of 1/3 EV in P, S, A, M, scene, and 📷 modes
Exposure lock	Luminosity locked at detected value with $\frac{AE-L}{AF-L}$ (🔒) button
ISO sensitivity (Recommended Exposure Index)	ISO 100 – 25600 in steps of 1 EV. Auto ISO sensitivity control available
Active D-Lighting	On, off

Focus	
Autofocus	Nikon Multi-CAM 1000 autofocus sensor module with TTL phase detection, 11 focus points (including one cross-type sensor), and AF-assist illuminator (range approx. 0.5–3 m/1 ft 8 in.–9 ft 10 in.)
Detection range	–1 – +19 EV (ISO 100, 20 °C/68 °F)
Lens servo	<ul style="list-style-type: none"> • Autofocus (AF): Single-servo AF (AF-S); continuous-servo AF (AF-C); auto AF-S/AF-C selection (AF-A); predictive focus tracking activated automatically according to subject status • Manual focus (MF): Electronic rangefinder can be used
Focus point	Can be selected from 11 focus points
AF-area mode	Single-point AF, dynamic-area AF, auto-area AF, 3D-tracking (11 points)
Focus lock	Focus can be locked by pressing shutter-release button halfway (single-servo AF) or by pressing AF-L () button
Flash	
Built-in flash	 : Auto flash with auto pop-up P, S, A, M: Manual pop-up with button release
Guide Number	Approx. 7/22, 8/26 with manual flash (m/ft, ISO 100, 20 °C/68 °F)
Flash control	TTL: i-TTL flash control using 420-pixel RGB sensor is available with built-in flash; i-TTL balanced fill-flash for digital SLR is used with matrix and center-weighted metering, standard i-TTL flash for digital SLR with spot metering
Flash mode	Auto, auto with red-eye reduction, auto slow sync, auto slow sync with red-eye reduction, fill-flash, red-eye reduction, slow sync, slow sync with red-eye reduction, rear-curtain with slow sync, rear-curtain sync, off

Flash	
Flash compensation	Can be adjusted by -3 – $+1$ EV in increments of $\frac{1}{3}$ EV in P, S, A, M , and scene modes
Flash-ready indicator	Lights when built-in flash or optional flash unit is fully charged; flashes after flash is fired at full output
Accessory shoe	ISO 518 hot-shoe with sync and data contacts and safety lock
Nikon Creative Lighting System (CLS)	Nikon CLS supported
Sync terminal	AS-15 sync terminal adapter (available separately)
White balance	
White balance	Auto, incandescent, fluorescent (7 types), direct sunlight, flash, cloudy, shade, preset manual, all except preset manual with fine-tuning
Live view	
Lens servo	<ul style="list-style-type: none"> • Autofocus (AF): Single-servo AF (AF-S); full-time-servo AF (AF-F) • Manual focus (MF)
AF-area mode	Face-priority AF, wide-area AF, normal-area AF, subject-tracking AF
Autofocus	Contrast-detect AF anywhere in frame (camera selects focus point automatically when face-priority AF or subject-tracking AF is selected)
Automatic scene selection	Available in  and  modes
Movie	
Metering	TTL exposure metering using main image sensor
Metering method	Matrix
Frame size (pixels) and frame rate	<ul style="list-style-type: none"> • 1920 × 1080; 60p (progressive), 50p, 30p, 25p, 24p • 1280 × 720; 60p, 50p <p>Actual frame rates for 60p, 50p, 30p, 25p, and 24p are 59.94, 50, 29.97, 25, and 23.976 fps respectively; options support both ★ high and normal image quality</p>

Movie	
File format	MOV
Video compression	H.264/MPEG-4 Advanced Video Coding
Audio recording format	Linear PCM
Audio recording device	Built-in monaural microphone; sensitivity adjustable
ISO sensitivity	ISO 100–25600
Monitor	
Monitor	7.5-cm (3-in.), approx. 921k-dot (VGA) TFT LCD with 170 ° viewing angle, approx. 100% frame coverage, and brightness adjustment
Playback	
Playback	Full-frame and thumbnail (4, 9, or 72 images or calendar) playback with playback zoom, playback zoom cropping, playback face zoom, movie playback, photo and/or movie slide shows, histogram display, highlights, photo information, location data display, auto image rotation, picture rating, and image comment (up to 36 characters)
Interface	
USB	Hi-Speed USB with Micro-USB connector; connection to built-in USB port is recommended
HDMI output	Type C HDMI connector
Bluetooth	
Communication protocols	Bluetooth Specification Version 4.1
Operating frequency	<ul style="list-style-type: none"> • Bluetooth: 2402–2480 MHz • Bluetooth Low Energy: 2402–2480 MHz
Maximum output power	8.1 dBm (EIRP)
Range (line of sight)	Approximately 10 m (32 ft) without interference; range may vary with signal strength and presence or absence of obstacles

Supported languages	
Supported languages	Arabic, Bengali, Bulgarian, Chinese (Simplified and Traditional), Czech, Danish, Dutch, English, Finnish, French, German, Greek, Hindi, Hungarian, Indonesian, Italian, Japanese, Korean, Marathi, Norwegian, Persian, Polish, Portuguese (Portugal and Brazil), Romanian, Russian, Serbian, Spanish, Swedish, Tamil, Telugu, Thai, Turkish, Ukrainian, Vietnamese
Power source	
Battery	One EN-EL14a rechargeable Li-ion battery
AC adapter	EH-5b AC adapter; requires EP-5A power connector (available separately)
Tripod socket	
Tripod socket	1/4 in. (ISO 1222)
Dimensions/weight	
Dimensions (W × H × D)	Approx. 124 × 98 × 75.5 mm (4.9 × 3.9 × 3 in.)
Weight	Approx. 445 g (15.7 oz) with battery and memory card but without body cap; approx. 395 g/14 oz (camera body only)
Operating environment	
Temperature	0 °C–40 °C (+32 °F–104 °F)
Humidity	85% or less (no condensation)

- Unless otherwise stated, all measurements are performed in conformity with Camera and Imaging Products Association (CIPA) standards or guidelines.
- All figures are for a camera with a fully-charged battery.
- The sample images displayed on the camera and the images and illustrations in the manual are for expository purposes only.
- Nikon reserves the right to change the appearance and specifications of the hardware and software described in this manual at any time and without prior notice. Nikon will not be held liable for damages that may result from any mistakes that this manual may contain.

■ ■ MH-24 Battery Charger

Rated input	AC 100–240 V, 50/60 Hz, 0.2 A maximum
Rated output	DC 8.4 V/0.9 A
Supported batteries	Nikon EN-EL14a rechargeable Li-ion batteries
Charging time	Approx. 1 hour and 50 minutes at an ambient temperature of 25 °C (77 °F) when no charge remains
Operating temperature	0 °C–40 °C (+32 °F–104 °F)
Dimensions (W × H × D)	Approx. 70 × 26 × 97 mm (2.8 × 1.0 × 3.8 in.), excluding plug adapter
Weight	Approx. 96 g (3.4 oz), excluding plug adapter

The symbols on this product represent the following:

~ AC, --- DC,  Class II equipment (The construction of the product is double-insulated.)

■ ■ EN-EL14a Rechargeable Li-ion Battery

Type	Rechargeable lithium-ion battery
Rated capacity	7.2 V/1230 mAh
Operating temperature	0 °C–40 °C (+32 °F–104 °F)
Dimensions (W × H × D)	Approx. 38 × 53 × 14 mm (1.5 × 2.1 × 0.6 in.)
Weight	Approx. 49 g (1.7 oz), excluding terminal cover

Nikon reserves the right to change the appearance and specifications of the hardware and software described in this manual at any time and without prior notice. Nikon will not be held liable for damages that may result from any mistakes that this manual may contain.

■ ■ *Supported Standards*

- **DCF Version 2.0:** The Design Rule for Camera File Systems (DCF) is a standard widely used in the digital camera industry to ensure compatibility among different makes of camera.
- **Exif version 2.3:** The D3400 supports Exif (**Exchangeable Image File Format for Digital Still Cameras**) version 2.3, a standard in which information stored with photographs is used for optimal color reproduction when the images are output on Exif-compliant printers.
- **PictBridge:** A standard developed through cooperation with the digital camera and printer industries, allowing photographs to be output directly to a printer without first transferring them to a computer.
- **HDMI: High-Definition Multimedia Interface** is a standard for multimedia interfaces used in consumer electronics and AV devices capable of transmitting audiovisual data and control signals to HDMI-compliant devices via a single cable connection.

Trademark Information

IOS is a trademark or registered trademark of Cisco Systems, Inc., in the United States and/or other countries and is used under license. Windows is either a registered trademark or a trademark of Microsoft Corporation in the United States and/or other countries. Mac, OS X, Apple®, App Store®, the Apple logos, iPhone®, iPad®, and iPod touch® are trademarks of Apple Inc. registered in the U.S. and/or other countries. Android is a trademark of Google Inc. The Android robot is reproduced or modified from work created and shared by Google and used according to terms described in the Creative Commons 3.0 Attribution License. PictBridge logo is a trademark. The SD, SDHC, and SDXC logos are trademarks of the SD-3C, LLC. HDMI, the HDMI logo and High-Definition Multimedia Interface are trademarks or registered trademarks of HDMI Licensing LLC.

HDMI

The Bluetooth® word mark and logos are registered trademarks owned by Bluetooth SIG, Inc. and any use of such marks by Nikon Corporation is under license.

All other trade names mentioned in this manual or the other documentation provided with your Nikon product are trademarks or registered trademarks of their respective holders.

“Made for iPod,” “Made for iPhone,” and “Made for iPad” mean that an electronic accessory has been designed to connect specifically to iPod, iPhone, or iPad, respectively, and has been certified by the developer to meet Apple performance standards. Apple is not responsible for the operation of this device or its compliance with safety and regulatory standards. Please note that the use of this accessory with iPod, iPhone, or iPad may affect wireless performance.

Conformity Marking

The standards with which the camera complies can be viewed using the **Conformity marking** option in the setup menu (☐ 225).

FreeType License (FreeType2)

Portions of this software are copyright © 2012 The FreeType Project (<http://www.freetype.org>). All rights reserved.

MIT License (HarfBuzz)

Portions of this software are copyright © 2016 The HarfBuzz Project (<http://www.freedesktop.org/wiki/Software/HarfBuzz>). All rights reserved.

Certificates

Indonesia

44633/SDPPI/2016
4588

44168/SDPPI/2016
4593

الإمارات العربية المتحدة

TRA
REGISTERED No:
ER45170/16
DEALER No:
DA39487/15

México

IFETEL: RCPMUTY16-0164
TYPE1FJ

Módulo WLAN instalado adentro de esta computadora

La operación de este equipo está sujeta a las siguientes condiciones:

- (1) es posible que este equipo o dispositivo no cause interferencia perjudicial y
- (2) este equipo o dispositivo debe aceptar cualquier interferencia, incluyendo la que pueda causar su operación no deseada.

Paraguay

Número del Registro: 2015-12-I-0000358

Este producto contiene un transmisor aprobado por la CONATEL.

Brasil

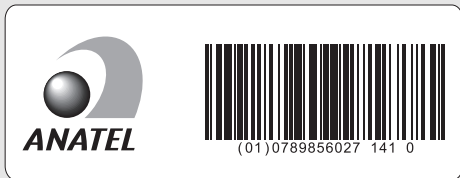

AF-P DX NIKKOR 18–55mm f/3.5–5.6G VR and AF-P DX NIKKOR 18–55mm f/3.5–5.6G Lenses

Read this section if you purchased the camera with the AF-P DX NIKKOR 18–55mm f/3.5–5.6G VR or AF-P DX NIKKOR 18–55mm f/3.5–5.6G lens kit available in some countries or regions. The parts of the lens are listed below.

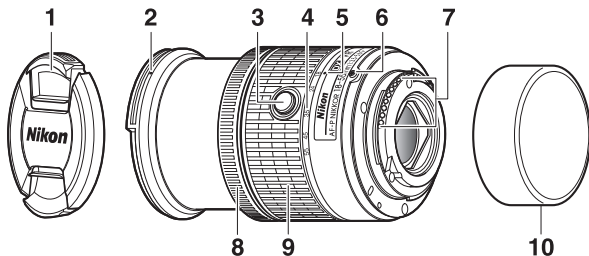

1	Lens cap	6	Lens mounting mark 15
2	Lens hood mounting mark	7	CPU contacts 253
3	Retractable lens barrel button ... 16	8	Focus ring 81
4	Focal length scale	9	Zoom ring 34
5	Focal length mark	10	Rear lens cap

These retractable lenses are for use exclusively with DX format Nikon digital SLR cameras; SLR film cameras and D3-series, D2-series, D1-series, D700, D300-series, D200, D100, D90, D80, D70-series, D60, D50, D40-series, D7000, D5100, D5000, D3200, D3100, D3000 digital SLR cameras are not supported. When using these lenses with a D5, D4-series, D810-series, D800-series, Df, D750, D610, D600, D7200, D7100, D5500, D5300, or D3300, be sure the camera firmware has been updated to the latest version.

■ ■ Focus

The focus mode can be selected using camera controls (☞ 69).

Autofocus

Focus is adjusted automatically when the camera is in autofocus mode (☞ 69). The focus ring can also be used to focus the camera if the shutter-release button is kept pressed halfway (or if the AF-ON button is kept pressed); this is known as “autofocus with manual override” (M/A). Autofocus will resume when the shutter-release button is pressed halfway (or the AF-ON button is pressed) a second time. Note that touching the focus ring while autofocus is in effect will change the focus position.

Manual Focus

When the camera is in manual focus mode, focus can be adjusted by rotating the lens focus ring (☞ 81). When the camera is off or the standby timer has expired, the focus ring can not be used to focus and rotating the zoom ring will change the focus position; before focusing, turn the camera on or press the shutter-release button to reactivate the standby timer.

Users of D5200 cameras should note that if the standby timer is allowed to expire, the focus position will change when the timer is restarted. Refocus before shooting. Longer standby times are recommended for manual focus and in other situations in which you may not release the shutter immediately after focusing.

■ ■ Using the Built-in Flash

When using the built-in flash, be sure the subject is at a range of at least 0.6 m (2 ft) and remove lens hoods to prevent vignetting (shadows created where the end of the lens obscures the built-in flash).

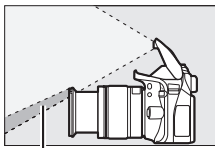

Shadow



Vignetting

Camera	Zoom position	Minimum distance without vignetting
D5500/D5300/D5200/ D3400/D3300	18 mm	1.0 m/3 ft 4 in.
	24, 35, 45, and 55 mm	No vignetting

■ ■ **Vibration Reduction (VR, AF-P DX NIKKOR 18–55mm f/3.5–5.6G VR Only)**

When an AF-P DX NIKKOR 18–55mm f/3.5–5.6G VR is mounted on the camera, vibration reduction can be enabled or disabled using the **Optical VR** option in the shooting menu (☐ 198). If **On** is selected, vibration reduction will take effect whenever the shutter-release button is pressed halfway. Vibration reduction reduces blur caused by camera shake, allowing shutter speeds up to 4.0 stops slower than would otherwise be the case, increasing the range of shutter speeds available. The effects of VR on shutter speed are measured according to Camera and Imaging Products Association (CIPA) standards; FX-format lenses are measured using FX-format digital SLR cameras, DX-format lenses using DX-format cameras. Zoom lenses are measured at maximum zoom.

✔ **Vibration Reduction**

- When using vibration reduction, press the shutter-release button halfway and wait for the image in the viewfinder to stabilize before pressing the shutter-release button the rest of the way down.
- When vibration reduction is active, the image in the viewfinder may jiggle after the shutter is released. This does not indicate a malfunction.
- When the camera is panned, vibration reduction applies only to motion that is not part of the pan (if the camera is panned horizontally, for example, vibration reduction will be applied only to vertical shake), making it much easier to pan the camera smoothly in a wide arc.
- If the camera is equipped with a built-in flash, vibration reduction will be disabled while the flash charges.
- Vibration reduction is generally recommended when the camera is mounted on a tripod, although you may prefer to turn it off depending on shooting conditions and the type of tripod.
- Vibration reduction is recommended when the camera is mounted on a monopod.

■ Supplied Accessories

- LC-55A 55 mm Snap-on Front Lens Cap
- Rear Lens Cap

■ Compatible Accessories

- 55 mm screw-on filters
- LF-4 Rear Lens Cap
- CL-0815 Lens Case
- HB-N106 Bayonet Hood

Align the lens hood mounting mark (●) with the lens hood alignment mark (┌) as shown in Figure ① and then rotate the hood (②) until the ● mark is aligned with the lens hood lock mark (—○).

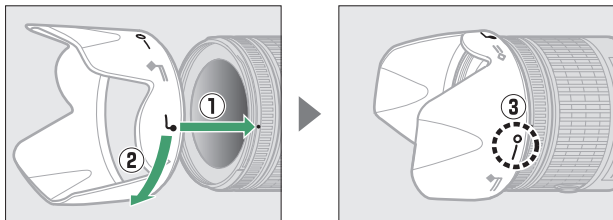

When attaching or removing the hood, hold it near the symbol on its base and avoid gripping it too tightly. Vignetting may occur if the hood is not correctly attached. The hood can be reversed and mounted on the lens when not in use.

■ Specifications

Type	Type G AF-P DX lens with built-in CPU and F mount
Focal length	18–55 mm
Maximum aperture	f/3.5–5.6
Lens construction	12 elements in 9 groups (2 aspherical lens elements)
Angle of view	76° – 28° 50'
Focal length scale	Graduated in millimeters (18, 24, 35, 45, 55)
Distance information	Output to camera
Zoom	Manual zoom using independent zoom ring
Focusing	Autofocus controlled by stepping motor; separate focus ring for manual focus
Vibration reduction (AF-P DX NIKKOR 18–55mm f/3.5–5.6G VR only)	Lens shift using voice coil motors (VCMs)
Minimum focus distance	0.25 m (0.9 ft) from focal plane (□ 82) at all zoom positions
Diaphragm blades	7 (rounded diaphragm opening)
Diaphragm	Fully automatic
Aperture range	<ul style="list-style-type: none">• 18 mm focal length: f/3.5–22• 55 mm focal length: f/5.6–38 The minimum aperture displayed may vary depending on the size of the exposure increment selected with the camera.
Metering	Full aperture
Filter-attachment size	55 mm (P = 0.75 mm)
Dimensions	Approx. 64.5 mm maximum diameter × 62.5 mm (distance from camera lens mount flange when lens is retracted)
Weight	<ul style="list-style-type: none">• AF-P DX NIKKOR 18–55mm f/3.5–5.6G VR: Approx. 205 g (7.3 oz)• AF-P DX NIKKOR 18–55mm f/3.5–5.6G: Approx. 195 g (6.9 oz)

AF-P DX NIKKOR 70–300mm f/4.5–6.3G ED VR and AF-P DX NIKKOR 70–300mm f/4.5–6.3G ED Lenses

Read this section if you purchased the camera with the AF-P DX NIKKOR 70–300mm f/4.5–6.3G ED VR or AF-P DX NIKKOR 70–300mm f/4.5–6.3G ED lens kit available in some countries or regions. The parts of the lens are listed below.

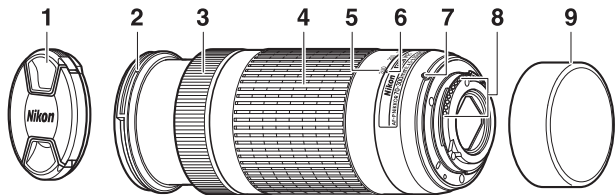

1 Lens cap

2 Lens hood mounting mark

3 Focus ring81

4 Zoom ring.....34

5 Focal length scale

6 Focal length mark

7 Lens mounting mark 15

8 CPU contacts 253

9 Rear lens cap

These lenses are for use exclusively with DX format Nikon digital SLR cameras; SLR film cameras and D3-series, D2-series, D1-series, D700, D300-series, D200, D100, D90, D80, D70-series, D60, D50, D40-series, D7000, D5100, D5000, D3200, D3100, D3000 digital SLR cameras are not supported. When using these lenses with a D5, D4-series, D810-series, D800-series, Df, D750, D610, D600, D7200, D7100, D5500, D5300, or D3300, be sure the camera firmware has been updated to the latest version.

■ ■ Focus

The focus mode can be selected using camera controls (☞ 69). Autofocus and rangefinder features are supported at all focal lengths. When using this lens, ignore any sections of the camera manual listing autofocus and rangefinder restrictions for lenses with a maximum aperture slower than f/5.6.

Autofocus

Focus is adjusted automatically when the camera is in autofocus mode (☞ 69). The focus ring can also be used to focus the camera if the shutter-release button is kept pressed halfway (or if the AF-ON button is kept pressed); this is known as “autofocus with manual override” (M/A). Autofocus will resume when the shutter-release button is pressed halfway (or the AF-ON button is pressed) a second time. Note that touching the focus ring while autofocus is in effect will change the focus position.

Manual Focus

When the camera is in manual focus mode, focus can be adjusted by rotating the lens focus ring (☞ 81). When the camera is off or the standby timer has expired, the focus ring can not be used to focus and rotating the zoom ring will change the focus position; before focusing, turn the camera on or press the shutter-release button to reactivate the standby timer.

Users of D5200 cameras should note that if the standby timer is allowed to expire, the focus position will change when the timer is restarted. Refocus before shooting. Longer standby times are recommended for manual focus and in other situations in which you may not release the shutter immediately after focusing.

■ **Vibration Reduction (VR, AF-P DX NIKKOR 70–300 mm f/4.5–6.3G ED VR Only)**

When an AF-P DX NIKKOR 70–300 mm f/4.5–6.3G ED VR is mounted on the camera, vibration reduction can be enabled or disabled using the **Optical VR** option in the shooting menu (☞ 198). If **On** is selected, vibration reduction will take effect whenever the shutter-release button is pressed halfway. Vibration reduction reduces blur caused by camera shake, allowing shutter speeds up to 4.0 stops slower than would otherwise be the case, increasing the range of shutter speeds available. The effects of VR on shutter speed are measured according to Camera and Imaging Products Association (CIPA) standards; FX-format lenses are measured using FX-format digital SLR cameras, DX-format lenses using DX-format cameras. Zoom lenses are measured at maximum zoom.

✓ **Vibration Reduction**

- When using vibration reduction, press the shutter-release button halfway and wait for the image in the viewfinder to stabilize before pressing the shutter-release button the rest of the way down.
- When vibration reduction is active, the image in the viewfinder may jiggle after the shutter is released. This does not indicate a malfunction.
- When the camera is panned, vibration reduction applies only to motion that is not part of the pan (if the camera is panned horizontally, for example, vibration reduction will be applied only to vertical shake), making it much easier to pan the camera smoothly in a wide arc.
- If the camera is equipped with a built-in flash, vibration reduction will be disabled while the flash charges.
- Vibration reduction is generally recommended when the camera is mounted on a tripod, although you may prefer to turn it off depending on shooting conditions and the type of tripod.
- Vibration reduction is recommended when the camera is mounted on a monopod.

■ ■ Supplied Accessories

- LC-58 58 mm Snap-on Front Lens Cap
- Rear Lens Cap

■ ■ Compatible Accessories

- 58 mm screw-on filters
- LF-4 Rear Lens Cap
- CL-1020 Lens Case
- HB-77 Bayonet Hood

Align the lens hood mounting mark (●) with the lens hood alignment mark (┌) as shown in Figure ① and then rotate the hood (②) until the ● mark is aligned with the lens hood lock mark (—○).

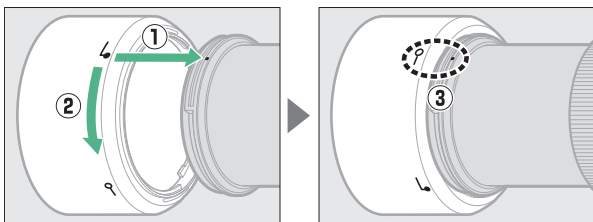

When attaching or removing the hood, hold it near the symbol on its base and avoid gripping it too tightly. Vignetting may occur if the hood is not correctly attached. The hood can be reversed and mounted on the lens when not in use. When the hood is reversed, it can be attached and removed by rotating it while holding it near the lock mark (—○).

■ Specifications

Type	Type G AF-P DX lens with built-in CPU and F mount
Focal length	70–300 mm
Maximum aperture	f/4.5–6.3
Lens construction	14 elements in 10 groups (including 1 ED lens element)
Angle of view	22° 50′ – 5° 20′
Focal length scale	Graduated in millimeters (70, 100, 135, 200, 300)
Distance information	Output to camera
Zoom	Manual zoom using independent zoom ring
Focusing	Autofocus controlled by stepping motor; separate focus ring for manual focus
Vibration reduction (AF-P DX NIKKOR 70–300mm f/4.5–6.3G ED VR only)	Lens shift using voice coil motors (VCMs)
Minimum focus distance	1.1 m (3.7 ft) from focal plane (□ 82) at all zoom positions
Diaphragm blades	7 (rounded diaphragm opening)
Diaphragm	Fully automatic
Aperture range	<ul style="list-style-type: none">• 70 mm focal length: f/4.5–22• 300 mm focal length: f/6.3–32 The minimum aperture displayed may vary depending on the size of the exposure increment selected with the camera.
Metering	Full aperture
Filter-attachment size	58 mm (P = 0.75 mm)
Dimensions	Approx. 72 mm maximum diameter × 125 mm (distance from camera lens mount flange)
Weight	<ul style="list-style-type: none">• AF-P DX NIKKOR 70–300mm f/4.5–6.3G ED VR: Approx. 415 g (14.7 oz)• AF-P DX NIKKOR 70–300mm f/4.5–6.3G ED: Approx. 400 g (14.2 oz)

AF-S DX NIKKOR 55–200mm f/4–5.6G ED VR II Lenses

Read this section if you purchased the camera with the AF-S DX NIKKOR 55–200mm f/4–5.6G ED VR II lens kit available in some countries or regions. The parts of the lens are listed below.

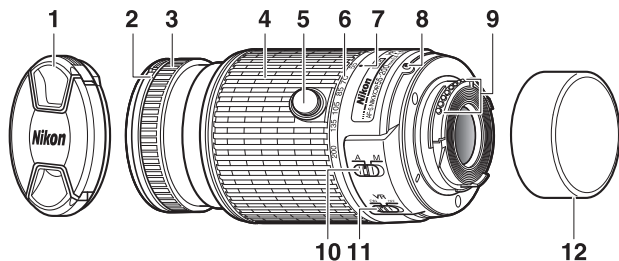

1	Lens cap	8	Lens mounting mark	15	
2	Lens hood mounting mark	9	CPU contacts	253	
3	Focus ring	81	10	A-M mode switch	81
4	Zoom ring	34	11	Vibration reduction ON/OFF switch	318
5	Retractable lens barrel button	16	12	Rear lens cap	
6	Focal length scale				
7	Focal length mark				

This retractable lens is for use exclusively with DX format Nikon digital cameras.

Focus

Focus mode is determined by the camera focus mode and the position of the lens A-M mode switch (☐ 81).

■ ■ **Vibration Reduction (VR)**

Vibration reduction can be enabled by sliding the vibration reduction switch to **ON** and takes effect whenever the shutter-release button is pressed halfway. Vibration reduction reduces blur caused by camera shake, allowing shutter speeds up to 4.0 stops slower than would otherwise be the case and increasing the range of shutter speeds available. The effects of VR on shutter speed are measured according to Camera and Imaging Products Association (CIPA) standards; FX-format lenses are measured using FX-format SLR digital cameras, DX-format lenses using DX-format cameras. Zoom lenses are measured at maximum zoom.



✓ **Vibration Reduction**

- When using vibration reduction, press the shutter-release button halfway and wait for the image in the viewfinder to stabilize before pressing the shutter-release button the rest of the way down.
- When vibration reduction is active, the image in the viewfinder may jiggle after the shutter is released. This does not indicate a malfunction.
- When the camera is panned, vibration reduction applies only to motion that is not part of the pan (if the camera is panned horizontally, for example, vibration reduction will be applied only to vertical shake), making it much easier to pan the camera smoothly in a wide arc.
- Do not turn the camera off or remove the lens while vibration reduction is in effect.
- If the camera is equipped with a built-in flash, vibration reduction will be disabled while the flash charges.
- Select **OFF** when the camera is mounted on a tripod unless the tripod head is unsecured or the camera is mounted on a monopod, in which case **ON** is recommended.

■ ■ Supplied Accessories

- LC-52 52 mm Snap-on Front Lens Cap
- Rear Lens Cap

■ ■ Compatible Accessories

- 52 mm screw-on filters
- LF-4 Rear Lens Cap
- CL-0915 Flexible Lens Pouch
- HB-37 Bayonet Hood

Align the lens hood mounting mark (●) with the lens hood alignment mark (└) as shown in Figure ① and then rotate the hood (②) until the ● mark is aligned with the lens hood lock mark (—○).

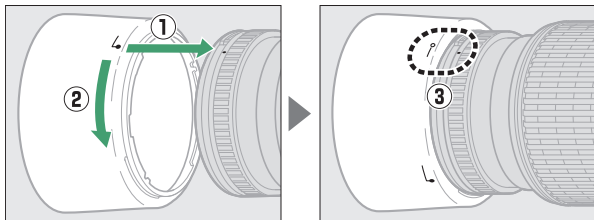

When attaching or removing the hood, hold it near the symbol on its base and avoid gripping it too tightly. Vignetting may occur if the hood is not correctly attached. The hood can be reversed and mounted on the lens when not in use. When the hood is reversed, it can be attached and removed by rotating it while holding it near the lock mark (—○).

■ Specifications

Type	Type G AF-S DX lens with built-in CPU and F mount
Focal length	55–200 mm
Maximum aperture	f/4–5.6
Lens construction	13 elements in 9 groups (including 1 ED lens element)
Angle of view	28° 50' – 8°
Focal length scale	Graduated in millimeters (55, 70, 85, 105, 135, 200)
Distance information	Output to camera
Zoom	Manual zoom using independent zoom ring
Focusing	Nikon Internal Focusing (IF) System with autofocus controlled by Silent Wave Motor and separate focus ring for manual focus
Vibration reduction	Lens shift using voice coil motors (VCMs)
Minimum focus distance	1.1 m (3.7 ft) from focal plane (□ 82) at all zoom positions
Diaphragm blades	7 (rounded diaphragm opening)
Diaphragm	Fully automatic
Aperture range	<ul style="list-style-type: none">• 55 mm focal length: f/4–22• 200 mm focal length: f/5.6–32
Metering	Full aperture
Filter-attachment size	52 mm (P = 0.75 mm)
Dimensions	Approx. 70.5 mm maximum diameter × 83 mm (distance from camera lens mount flange when lens is retracted)
Weight	Approx. 300 g (10.6 oz)

Nikon reserves the right to change the appearance and specifications of the hardware and software described in this manual at any time and without prior notice. Nikon will not be held liable for damages that may result from any mistakes that this manual may contain.

✓ Lens Care

- Keep the CPU contacts clean.
- Use a blower to remove dust and lint from the lens surfaces. To remove smudges and fingerprints, apply a small amount of ethanol or lens cleaner to a soft, clean cotton cloth or lens-cleaning tissue and clean from the center outwards using a circular motion, taking care not to leave smears or touch the glass with your fingers.
- Never use organic solvents such as paint thinner or benzene to clean the lens.
- The lens hood or NC filters can be used to protect the front lens element.
- Attach the front and rear caps before placing the lens in its case.
- When a lens hood is attached, do not pick up or hold the lens or camera using only the hood.
- If the lens will not be used for an extended period, store it in a cool, dry location to prevent mold and rust. Do not store in direct sunlight or with naphtha or camphor moth balls.
- Keep the lens dry. Rusting of the internal mechanism can cause irreparable damage.
- Leaving the lens in extremely hot locations could damage or warp parts made from reinforced plastic.

A Note on Wide- and Super Wide-Angle Lenses

Autofocus may not provide the desired results in situations like those shown below.

1 Objects in the background occupy more of the focus point than the main subject:

If the focus point contains both foreground and background objects, the camera may focus on the background and the subject may be out of focus, particularly with wide- and super wide-angle lenses.



Example: *A far-off portrait subject at some distance from the background*

2 The subject contains many fine details.

The camera may have difficulty focusing on subjects that contain many fine details.

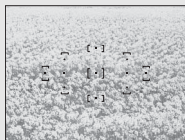

Example: *A field of flowers*

In these cases, use manual focus, or use focus lock to focus on another subject at the same distance and then recompose the photograph. For more information, see “Getting Good Results with Autofocus” (□ 72).

Memory Card Capacity

The following table shows the approximate number of pictures that can be stored on a 16 GB SanDisk Extreme Pro SDHC UHS-I card at different image quality and size settings.

Image quality	Image size	File size ¹	No. of images ¹	Buffer capacity ²
NEF (RAW)+JPEG fine ³	Large	33.0 MB	320	6
NEF (RAW)	—	20.5 MB	505	17
JPEG fine	Large	12.6 MB	920	100
	Medium	7.6 MB	1500	100
	Small	3.9 MB	2900	100
JPEG normal	Large	6.5 MB	1800	100
	Medium	3.9 MB	3000	100
	Small	2.0 MB	5600	100
JPEG basic	Large	2.5 MB	3500	100
	Medium	1.8 MB	5700	100
	Small	1.1 MB	10,300	100

- 1 All figures are approximate. Results will vary with card type, camera settings, and scene recorded.
- 2 Maximum number of exposures that can be stored in memory buffer at ISO 100. Drops when noise reduction (☐ 195), auto distortion control (☐ 196), or **Date stamp** (☐ 202) is on.
- 3 Image size applies to JPEG images only. Size of NEF (RAW) images can not be changed. File size is the total for NEF (RAW) and JPEG images.

Battery Life

The movie footage or number of shots that can be recorded with fully-charged batteries varies with the condition of the battery, temperature, the interval between shots, and the length of time menus are displayed. Sample figures for EN-EL14a (1230 mAh) batteries are given below.

- **Photographs, single-frame release mode (CIPA standard ¹):**

Approximately 1200 shots

- **Movies:** Approximately 60 minutes at 1080/60p²

- 1 Measured at 23 °C/73.4 °F (± 2 °C/3.6 °F) with an AF-P DX NIKKOR 18–55mm f/3.5–5.6G VR lens under the following test conditions: lens cycled from infinity to minimum range and one photograph taken at default settings once every 30 s; after photograph is taken, monitor is turned on for 4 s; tester waits for standby timer to expire after monitor is turned off; flash fired at full power once every other shot. Live view not used.
- 2 Measured at 23 °C/73.4 °F (± 2 °C/3.6 °F) with the camera at default settings and an AF-P DX NIKKOR 18–55mm f/3.5–5.6G VR lens under conditions specified by the Camera and Imaging Products Association (CIPA). Individual movies can be up to 20 minutes in length or 4 GB in size; recording may end before these limits are reached if the camera temperature rises.

The following can reduce battery life:



























- Using the monitor
- Keeping the shutter-release button pressed halfway
- Repeated autofocus operations
- Taking NEF (RAW) photographs
- Slow shutter speeds
- Using camera Bluetooth features
- Using the camera with optional accessories connected
- Using VR (vibration reduction) mode with VR lenses
- Repeatedly zooming in and out with an AF-P lens.

















To ensure that you get the most from rechargeable Nikon EN-EL14a batteries:

- Keep the battery contacts clean. Soiled contacts can reduce battery performance.
- Use batteries immediately after charging. Batteries will lose their charge if left unused.

Index

Symbols

 (Auto mode)	5, 32
 (Auto (flash off) mode)	5, 32
 (Portrait)	5, 48
 (Landscape)	5, 49
 (Child)	5, 49
 (Sports)	5, 49
 (Close up)	5, 50
 (Night portrait)	5, 50
EFFECTS (Special effects)	5, 51
 (Night vision)	52
VI (Super vivid)	52
POP (Pop)	52
 (Photo illustration)	53, 56
 (Toy camera effect)	53, 57
 (Miniature effect)	53, 58
 (Selective color)	54, 60
 (Silhouette)	54
 (High key)	54
 (Low key)	55
P (Programmed auto)	5, 98, 99
S (Shutter-priority auto)	5, 98, 101
A (Aperture-priority auto)	5, 98, 103
M (Manual)	5, 98, 105
GUIDE (Guide)	42
 (flexible program)	100
 (Single frame)	62
 (Continuous)	62, 63
 (Self-timer)	62, 66
 (Quiet shutter release)	62, 65
 2s (Delayed remote (ML-L3))	62, 95
 (Quick-response remote (ML-L3)) ..	62, 95
 (Single-point AF)	74
 (Dynamic-area AF)	74
 (Auto-area AF)	74
 (3D-tracking)	74

 (Face-priority AF)	75
 (Wide-area AF)	75
 (Normal-area AF)	75
 (Subject-tracking AF)	76
 (Matrix metering)	111
 (Center-weighted metering) ..	111
 (Spot metering)	111
AUTO (auto flash)	88
 (red-eye reduction)	88, 90
SLOW (slow sync)	88, 90
REAR (rear-curtain sync)	90
 (Flash compensation)	117
 (Exposure compensation)	115
WB (White balance)	121
PRE (Preset manual)	126
 (“Beep” indicator)	213
 (focus indicator)	35, 79, 82
 (flash-ready indicator) ...	4, 38, 265
 (live view) button	32, 138
 button	11, 143, 155
 button	6
 (memory buffer)	64, 323

Numerics

3D-tracking (AF-area mode)	74
420-pixel RGB sensor ...	198, 297, 298

A

AC adapter	267, 270
Access lamp	36
Accessories	267
Active D-Lighting	119
Adobe RGB	194
AE lock	113
AE-L	113
AE-L/AF-L button	80, 113, 215
AF	69–80
AF-A	69

AF activation	215	CEC	185
AF-area mode	74	Center-weighted metering	111
AF-assist illuminator	73, 196, 256	Charger	12, 267, 302
AF-C	69	Choose start/end point	146
AF-F	70	Clock	25, 205
AF-S	69, 70	Clock battery	13
Airplane mode	222	Cloudy (White balance)	121
A-M mode switch	81, 317	CLS	262
Angle of view	261	Color outline	243
Aperture	103, 106	Color sketch	244
Aperture-priority auto	103	Color space	194
Auto (White balance)	121	Color temperature	123
Auto distortion control	196	Compatible lenses	252
Auto flash	88	Conformity marking	225
Auto image rotation	188	Connect to smart device	222
Auto info display	206	Continuous (Release mode)	62, 63
Auto ISO sensitivity control	193, 194	Continuous-servo AF	69
Auto off timers	207	Copyright Information	212
Auto-area AF (AF-area mode)	74	CPU contacts	253
Autoexposure lock	113	CPU lens	252
Autofocus	69–80	Creative Lighting System	262
Auto-servo AF	69	Cropping (PictBridge)	182
Available settings	281	Cross screen (Filter effects)	239

B

Battery	12, 13, 31, 267, 302
Beep	213
Black-and-white	240
Bluetooth	xx, 223
Body cap	2, 268
Border (PictBridge)	182
Built-in AF-assist illuminator	73, 196, 256
Built-in flash	38, 87, 258
Bulb	107
Burst	63
Buttons	214

C

Calendar playback	154
Capture NX-D	177

D

Date and time	205
Date counter	202, 203
Date format	25, 205
Date stamp	202
Daylight saving time	25, 205
DCF version 2.0	303
Delayed remote (ML-L3)	62, 95
Delete	41, 171
Delete all images	172
Delete current image	171
Delete selected images	172
Device control (HDMI)	185
Diopter adjustment control	26, 268
Direct sunlight (White balance)	121
Distortion control	237

D-Lighting 235
Dynamic-area AF 74

E

Edit movie 146, 150
Electronic rangefinder 82, 216
Exif version 2.3 303
Exposure 111, 113, 115
Exposure compensation 115
Exposure indicator 10, 106
Exposure lock 113
Exposure meters 37
Exposure mode 98
Eye-Fi upload 224

F

Face-priority AF 75
Face zoom 167
File information 156, 157
File naming 221
File number sequence 218
Filter effects 135, 137, 239
Filters 267
Fine-tuning white balance 124
Firmware version 226
Fisheye 238
Flash 38, 87, 197, 262
Flash (White balance) 121
Flash cntrl for built-in flash 197
Flash compensation 117
Flash control 198
Flash mode 88, 90
Flash range 92
Flash ready indicator 4, 38, 265
Flash sync speed 91, 296
Flat (Set Picture Control) 132
Flexible program 100
Flicker reduction 140, 213
Fluorescent (White balance) 121,
123
Fn button 214

f-number 103
Focal length 261
Focal length scale 306, 312, 317
Focal plane mark 82
Focus 69–83
Focus indicator 35, 79, 82
Focus lock 79
Focus mode 69
Focus point 34, 74, 76, 82
Focusing screen 296
Focusing the viewfinder 26
Focus-mode switch 81
Format memory card 201
Frame interval (Slide show) 176
Frame size/frame rate 141
Framing grid 8
Front-curtain sync 90
Full-frame playback 152
Full-time-servo AF 70

G

Guide mode 42

H

H.264 300
HDMI 184, 303
HDMI-CEC 185
Help 28
Hi (Sensitivity) 93
High definition 184, 303
Highlights 157, 187
Histogram 158, 187

I

Image comment 211
Image Dust Off ref photo 209
Image overlay 241
Image quality 84
Image review 188
Image size 86
Image type (Slide show) 176

Incandescent (White balance)	121
Info display format	206
In-focus indicator	35, 79, 82
Information display	6, 206
Infrared receiver	96
ISO sensitivity	93, 192
i-TTL	197, 198, 262
i-TTL balanced fill-flash for digital SLR	198, 262

J

JPEG	84
JPEG basic	84
JPEG fine	84
JPEG normal	84

L

Landscape (Set Picture Control)	132
Language	19, 205
Large (Image size)	86
Lens	15, 252, 306
Lens focus ring	81, 306, 312, 317
Lens mount	2, 15, 82
Lens vibration reduction switch ..	17, 318
Live view	32, 138
Location data	164, 221
Lock mirror up for cleaning	273

M

Manual	81, 105
Manual focus	69, 70, 81
Manual focus ring in AF mode ...	217
Manual movie settings	142
Matrix metering	111
Maximum sensitivity	193
Medium (Image size)	86
Memory buffer	64, 323
Memory card	13, 201, 269, 323
Memory card capacity	323
Metering	111

Microphone	141
Miniature effect	58, 245
Minimum shutter speed	193
Mired	125
Mirror	2, 273
Mode dial	5
Monitor	152, 205
Monitor brightness	205
Monochrome	240
Monochrome (Set Picture Control) ..	132
Mounting mark	15, 306, 312, 317
Movie quality	141
Movie settings	141
Movie-record button	139
Movies	138

N

NEF (RAW)	84, 221, 230
NEF (RAW) processing	230
Neutral (Set Picture Control)	132
Nikon Transfer 2	179
No. of copies (PictBridge)	182
Noise reduction	195
Non-CPU lens	254
Normal-area AF	75
Number of exposures remaining .	31
Number of shots	324

O

Optical VR	198
Optional flash	197, 262
Output resolution (HDMI)	185
Overview data	163

P

Page size (PictBridge)	182
Painting	248
Perspective control	238
Photo illustration	56, 244
Photo information	156, 187

PictBridge	181, 303
Picture Controls	132, 134
Playback	40, 152
Playback display options	187
Playback folder	187
Playback information	156, 187
Playback menu	186
Playback zoom	165
Portrait (Set Picture Control)	132
Power connector	267, 270
Preset manual (White balance) .	121, 126
Press the shutter-release button all the way down	36
Press the shutter-release button halfway	35, 36
Print date (PictBridge)	182
Print select	183
Printing	181
Programmed auto	99
Protecting photographs	168

Q

Quick retouch	236
Quick-response remote (ML-L3) ..	62, 95
Quiet shutter release	62, 65

R

Rangefinder	82, 216
Rating	169, 176
Rear-curtain sync	90
Recent settings	251
Red-eye correction	236
Red-eye reduction	88, 90
Release mode	62
Remote control	95, 269
Remote on duration (ML-L3)	208
Reset	192, 201, 226
Reset all settings	226
Reset setup options	201

Reset shooting menu	192
Resize	233
Retouch menu	227
Retractable lens barrel button	16, 17, 306, 317
RGB	158, 194
RGB histogram	158
Rotate tall	189

S

Save selected frame	150
Scene auto selector	37
Scene mode	48
Select to send to smart device	189
Selective color	60, 246
Self-timer	62, 66, 208
Send to smart device (auto)	223
Sensitivity	93, 192
Sepia	240
Set Picture Control	134
Setup menu	199
Shade (White balance)	121
Shooting data	160
Shooting menu	190
Shutter-priority auto	101
Shutter-release button ...	36, 79, 113, 215
Side-by-side comparison	249
Single frame (Release mode)	62
Single-point AF (AF-area mode) ...	74
Single-servo AF	69, 70
Size	86, 141
Skylight (Filter effects)	239
Slide show	174
Slot empty release lock	226
Slow sync	88, 90
Small (Image size)	86
SnapBridge	i, 18
Soft (Filter effects)	239
Special effects mode	51
Speedlight	262

Spot metering	111
sRGB	194
Standard (Set Picture Control)	132
Standard i-TTL fill-flash for digital SLR	198, 262
Standby timer	37, 207
Start printing (PictBridge) ...	182, 183
Storage folder	219
Straighten	237
Subject-tracking AF	76
Sync with smart device	205

T

Television	184
Thumbnail playback	153
Time	107
Time zone	25, 205
Time zone and date	25, 205
Timer	66
Toning	135, 137
Trim	166, 232
Trimming movies	146
Type D lens	253
Type E lens	253
Type G lens	253

U

USB cable	178, 181, 268
-----------------	---------------

V

Vibration reduction	17, 198, 309, 314, 318
Viewfinder	4, 26, 296
Viewfinder eyepiece cap	68
ViewNX-i	177
Vignette control	195
Vivid (Set Picture Control)	132
Volume	145, 174

W

Warm filter (Filter effects)	239
WB	121
White balance	121
Wide-area AF	75
Wind noise reduction	142

No reproduction in any form of this manual, in whole or in part (except for brief quotation in critical articles or reviews), may be made without written authorization from NIKON CORPORATION.

NIKON CORPORATION

© 2016 Nikon Corporation



SB8E03(11)
6MB35411-03